



TILLOTSON LTD., CLASH INDUSTRIAL ESTATE,  
TRALEE, CO. KERRY, IRELAND

PHONE: +353 66 7121911 FAX: +353 66 7124503

e-mail: [sales@tillotson.ie](mailto:sales@tillotson.ie)







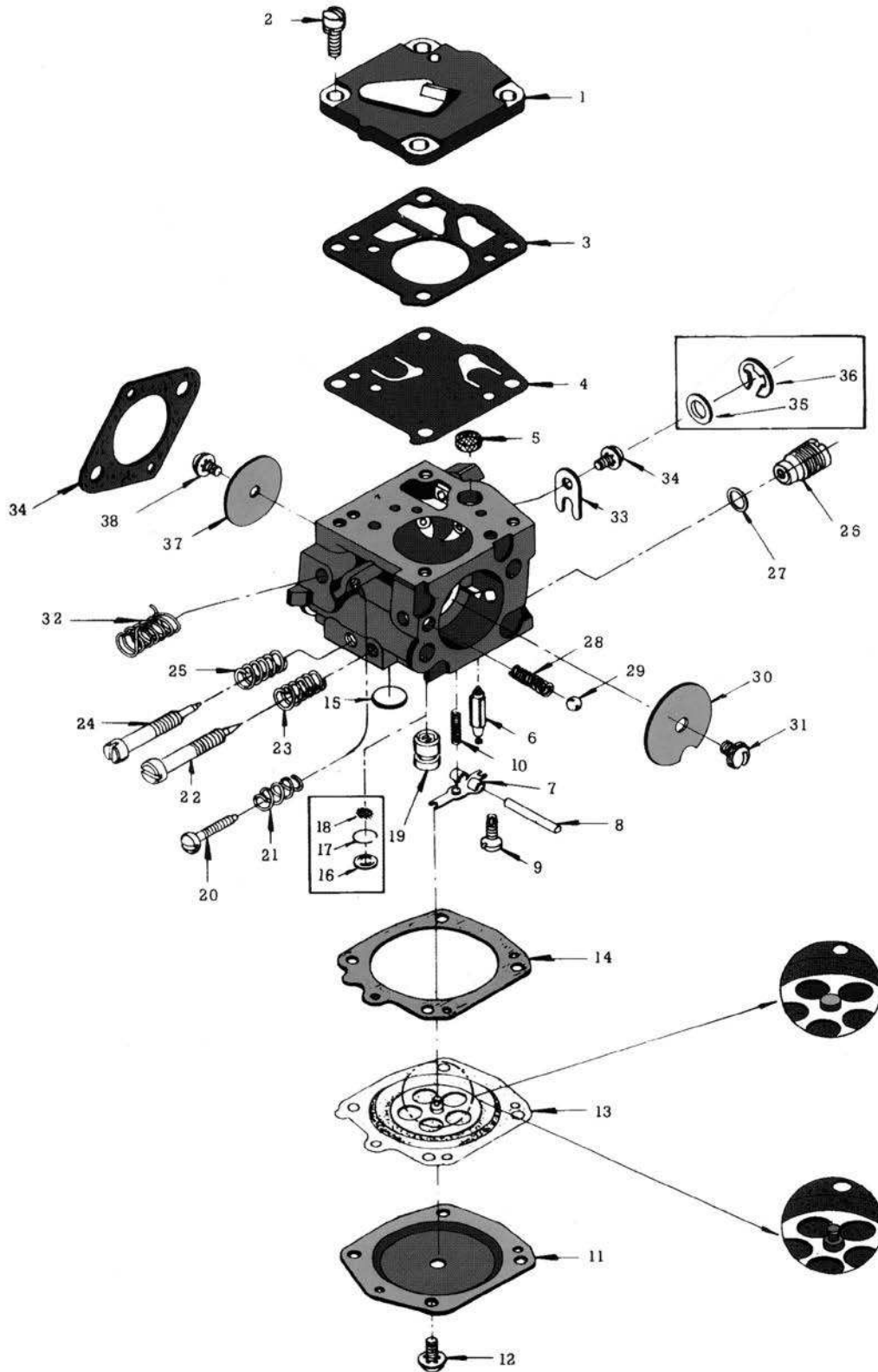







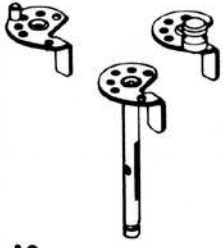









**PARTS LIST**

Illustration of basic parts throughout HS series carburettor.  
For individual model listing see following pages.





















Parts illustrated are typical in appearance and may not look exactly like the part required.





## SHAFT & LEVER ASSEMBLIES

 <p><b>A1</b></p>	 <p><b>A2</b></p>	 <p><b>A3</b></p>	 <p><b>A4</b></p>	 <p><b>A5</b></p>
 <p><b>A6</b></p>	 <p><b>A7</b></p>	 <p><b>A8</b></p>	 <p><b>A9</b></p>	 <p><b>A10</b></p>
 <p><b>A11</b></p>	 <p><b>A12</b></p>	 <p><b>A13</b></p>	 <p><b>A14</b></p>	 <p><b>A15</b></p>
 <p><b>A16</b></p>	 <p><b>A17</b></p>	 <p><b>A18</b></p>	 <p><b>A19</b></p>	 <p><b>A20</b></p>
 <p><b>A21</b></p>	 <p><b>A22</b></p>	 <p><b>A23</b></p>		

## MISCELLANEOUS PARTS

 B1	 B2	 B3	 B4	 B5
 B6	 B7	 B8	 B9	 B10
 B11	 B12	 B13	 B14	 B15
 B16	 B17	 B18		

## LEVERS

 C1	 C2	 C3	 C4	 C5
---	---	---	---	---



Carburetor Model		HS-4D	HS-5C
Customer		Homelite	Homelite
Equipment Model No.		XL-12/SXL-12/SXL-12 Auto	XLS 1 1/2 - 1A
Venturi		9/16" - 14.3 MM	9/16" - 14.3 MM
Ref. No.	Part Name		
1	Fuel Pump-Cover	91A-273	91A-273
2	Fuel Pump-Cover Screw (4)	15C-30	15C-30
+*3	Fuel Pump-Gasket	16B-227	16B-227
+*4	Fuel Pump-Diaphragm	237-144	237-144
*5	Fuel Pump-Inlet Screen	95-177	95-177
*6	Fuel Inlet-Needle	34-216	34-216
*7	Fuel Inlet-Control Lever	155A-26	155A-26
8	Fuel Inlet-Fulcrum Pin	32-78	32-78
9	Fuel Inlet-Fulcrum Pin Retaining Screw	15B-345	15B-345
10	Fuel Inlet-Tension Spring	24B-289	24-B323
11	Metering-Cover	91A-274	91A-274
12	Metering-Cover Screw (4)	15C-19	15C-19
+*13	Metering-Diaphragm	237-601	237-601
+*14	Metering-Diaphragm Gasket	16B-226	16B-226
*15	Metering-By Pass Chamber Welch Plug (Large)	179-59	179-59
*16	Metering-Main Nozzle Welch Plug (Small)	179-60	179-60
*17	Metering-Main Nozzle Screen	95-180	95-180
18	Metering-Main Nozzle Screen Retaining Ring	55A-212	55A-212
19	Metering-Nozzle Valve		
20	Idle Speed-Adjustment Screw		15B-330
21	Idle Speed-Adjustment Screw Spring		24B-298
22	Low Speed-Mixture Needle	43-417	43-417
23	Low Speed-Mixture Needle Spring	24B-449	24B-449
24	High Speed-Mixture Needle	43-418	43-418
25	High Speed-Mixture Needle Spring	24B-449	24B-449
26	High Speed-Governor Valve		
27	High Speed-Governor Valve Gasket		
A1	Choke-Shaft & Lever	26-983	26-983
28	Choke-Friction Spring	24B-281	24B-281
29	Choke-Friction Ball	206-121	206-121
30	Choke-Shutter	27-310	27-310
31	Choke-Shutter Screw	15C-20	
A3	Throttle-Shaft & Lever		13-1897
A7	Throttle-Shaft & Lever	13-1618	
32	Throttle-Return Spring	24B-326	
33	Throttle-Clip	29-224	
34	Throttle-Clip Retaining Screw	15C-20	
35	Throttle-Shaft Washer		78A-226
36	Throttle-Shaft E-Ring		29-220
37	Throttle-Shutter	14-471	14-471
38	Throttle-Shutter Screw	15C-20	15C-20
*39	Flange Gasket	16B-228	16B-228
	Repair Kit	RK-23HS	RK-23HS
	Diaphragm & Gasket Set	DG-5HS/T	DG-5HS/T

\*Indicates contents of Repair Kit

+Indicates contents of Diaphragm & Gasket Set



Carburetor Model		HS-118B	HS-121A	HS-123A
Customer		Andreas Stihl	Husqvarna	Husqvarna
Equipment Model No.		056AV	165R	65/77/160/163/180/260
Venturi		11/16" - 17.5 MM	5/8" - 15.9 MM	263/280/380 5/8" - 15.9 MM
Ref. No.	Part Name			
1	Fuel Pump-Cover	91A-295	91A-273	91A-273
2	Fuel Pump-Cover Screw (4)	15C-30	15C-30	15C-30
+*3	Fuel Pump-Gasket	16B-227	16B-227	16B-227
+*4	Fuel Pump-Diaphragm	237-144	237-144	237-144
*5	Fuel Pump-Inlet Screen	95-177	95-177	95-177
*6	Fuel Inlet-Needle	34-216	34-216	34-216
*7	Fuel Inlet-Control Lever	155A-26	155A-26	155A-26
8	Fuel Inlet-Fulcrum Pin	32-78	32-78	32-78
9	Fuel Inlet-Fulcrum Pin Retaining Screw	15B-345	15B-345	15B-345
10	Fuel Inlet-Tension Spring	24B-299	24B-299	24B-299
11	Metering-Cover	91-786	91A-274	91A-274
12	Metering-Cover Screw (4)	15C-19	15C-19	15C-19
+*13	Metering-Diaphragm	237-653	237-601	237-601
+*14	Metering-Diaphragm Gasket	16B-226	16B-226	16B-226
*15	Metering-By Pass Chamber Welch Plug (Large)	179-59	179-59	179-59
*16	Metering-Main Nozzle Welch Plug (Small)		179-60	179-60
*17	Metering-Main Nozzle Screen		95-180	95-180
18	Metering-Main Nozzle Screen Retaining Ring		55A-212	55A-212
19	Metering-Nozzle Valve	363-518		
20	Idle Speed-Adjustment Screw		15B-330	15B-330
21	Idle Speed-Adjustment Screw Spring		24B-298	24B-298
B1	Idle Speed-Adjustment Screw Cup		318-18	318-18
22	Low Speed-Mixture Needle	43A-70	43A-70	43A-70
23	Low Speed-Mixture Needle Spring	24B-331	24B-331	24B-331
24	High Speed-Mixture Needle	43A-108	43A-71	43A-71
25	High Speed-Mixture Needle Spring	24B-449	24B-331	24B-331
26	High Speed-Governor Valve			
27	High Speed-Governor Valve Gasket			
A1	Choke-Shaft & Lever			26-1239
A11	Choke-Shaft & Lever	26-1122		
A12	Choke-Shaft & Lever			
A23	Choke-Shaft & Lever		26-1124	
28	Choke-Friction Spring	24B-281	24B-281	24B-281
29	Choke-Friction Ball	206-121	206-121	206-121
30	Choke-Shutter	27-331	27-331	27-331
31	Choke-Shutter Screw	15C-20	15C-20	15C-20
B2	Choke-Shaft Cover			91A-323
B3	Choke-Shaft Sleeve			102-204
A3	Throttle-Shaft & Lever		13-1781	13-1897
A13	Throttle-Shaft & Lever	13-2028		
A17	Throttle-Shaft & Lever			
32	Throttle-Return Spring	24B-322	24B-322	24B-437
33	Throttle-Clip	29-224		
34	Throttle-Clip Retaining Screw	15C-20		
35	Throttle-Shaft Washer		78A-226	78A-226
36	Throttle-Shaft E-Ring		29-220	29-220
37	Throttle-Shutter	14-445	14-431	14-431
38	Throttle-Shutter Screw	15C-20	15C-20	15C-20
B3	Throttle-Shaft Sleeve (2)			102-204
*39	Flange Gasket	16-B262	16B-228	16B-228
	Repair Kit		RK-23HS	RK-23HS
	Diaphragm & Gasket Set		DG-5HS/T	DG-5HS/T

\*Indicates contents of Repair Kit

+Indicates contents of Diaphragm & Gasket Set





# HS SERIES

Carburetor Model		HS-128B	HS-135C	HS-136C
Customer		Oleo-Mac	Homelite	Husqvarna
Equipment Model No.		251B/S251/254/271/261	XL-98A/XL-98A-AP	185/285CD/298
Venturi		/271/272/350/364/950 AF 5/8" - 15.9 MM	5/8" - 15.9 MM	1100CD/2100/2100CD/2101 11/16"-17.5 MM
Ref. No.	Part Name			
1	Fuel Pump-Cover	91A-273	91A-273	91A-273
2	Fuel Pump-Cover Screw (4)	15C-30	15C-30	15C-30
+*3	Fuel Pump-Gasket	16B-227	16B-227	16B-227
+*4	Fuel Pump-Diaphragm	237-144	237-144	237-144
*5	Fuel Pump-Inlet Screen	95-177	95-177	95-177
*6	Fuel Inlet-Needle	34-216	34-216	34-216
*7	Fuel Inlet-Control Lever	155A-26	155A-26	155A-26
8	Fuel Inlet-Fulcrum Pin	32-78	32-78	32-78
9	Fuel Inlet-Fulcrum Pin Retaining Screw	15B-345	15B-345	15B-345
10	Fuel Inlet-Tension Spring	24B-299	24B-323	24B-299
11	Metering-Cover	91A-274	91A-274	91A-302
12	Metering-Cover Screw (4)	15C-19	15C-19	15C-19
+*13	Metering-Diaphragm	237-601	237-601	237-601
+*14	Metering-Diaphragm Gasket	16B-226	16B-226	16B-226
*15	Metering-By Pass Chamber Welch Plug (Large)	179-59	179-59	179-59
*16	Metering-Main Nozzle Welch Plug (Small)	179-60		179-60
*17	Metering-Main Nozzle Screen	95-180		95-180
18	Metering-Main Nozzle Screen Retaining Ring	55A-212		55A-212
19	Metering-Nozzle Valve		363-594	
20	Idle Speed-Adjustment Screw			
21	Idle Speed-Adjustment Screw Spring			
B1	Idle Speed-Adjustment Screw Cup			
22	Low Speed-Mixture Needle	43A-19	43-439	43A-70
23	Low Speed-Mixture Needle Spring	24B-331	24B-449	24B-331
24	High Speed-Mixture Needle	43A-20		43A-71
25	High Speed-Mixture Needle Spring	24B-449		24B-449
26	High Speed-Governor Valve		361-540	361-528
27	High Speed-Governor Valve Gasket		16B-204	16B-204
A4	Choke-Shaft & Lever			
A14	Choke-Shaft & Lever	26-1139		26-1238
A15	Choke-Shaft & Lever		26-1135	
28	Choke-Friction Spring	24B-281	24B-281	24B-281
29	Choke-Friction Ball	206-121	206-121	206-121
30	Choke-Shutter	27-331	27-310	27-331
31	Choke-Shutter Screw	15C-20	15C-20	15C-20
C1	Throttle-Lever	12-1164		
B4	Throttle-Lever Retaining Screw	15B-348		
A5	Throttle-Shaft & Lever			13-1893
A6	Throttle-Shaft & Lever	13-1662		
A7	Throttle-Shaft & Lever		13-1695	
32	Throttle-Return Spring	24B-406	24B-326	24B-437
33	Throttle-Clip	29-224	29-224	
34	Throttle-Clip Retaining Screw	15C-20		
35	Throttle-Shaft Washer			78A-226
36	Throttle-Shaft E-Ring			29-220
37	Throttle-Shutter	14-471	14-430	14-445
38	Throttle-Shutter Screw	15C-20	15C-20	15C-20
B3	Throttle-Shaft Sleeve			102-204
*39	Flange Gasket	16B-249	16B-228	16B-249
	Repair Kit	RK-23HS	RK-23HS	RK-23HS
	Diaphragm & Gasket Set	DG-5HT/T	DG-5HT/T	DG-5HT/T

\*Indicates contents of Repair Kit

+Indicates contents of Diaphragm & Gasket Set

Carburetor Model		HS-138B	HS-144E	HS-151B
Customer		Andreas Stihl	Alpina	Homelite
Equipment Model No.		041/041 AV	ZP-90/CP-120 PROF-90/PROF-120	XL-921,923,923FP,923ST,923KT XL-924/SXL 925/VI-944C/VI-955E
Venturi		11/16"-17.5 MM	11/16" -17.5 MM	5/8"-15.9 MM
Ref. No.	Part Name			
1	Fuel Pump-Cover	91-761	91A-273	91A-273
2	Fuel Pump-Cover Screw (4)	15C-30	15C-30	15C-30
+*3	Fuel Pump-Gasket	16B-227	16B-227	16B-227
+*4	Fuel Pump-Diaphragm	237-144	237-143	237-144
*5	Fuel Pump-Inlet Screen	95-177	95-177	95-177
*6	Fuel Inlet-Needle	34-216	34-216	34-216
*7	Fuel Inlet-Control Lever	155A-71	155A-26	155A-26
8	Fuel Inlet-Fulcrum Pin	32-78	32-78	32-78
9	Fuel Inlet-Fulcrum Pin Retaining Screw	15B-345	15B-345	15B-345
10	Fuel Inlet-Tension Spring	29B-299	29B-299	24B-323
B5	Fuel Inlet-Seat		36A-33	
11	Metering-Cover	91A-295	91A-274	91A-274
12	Metering-Cover Screw (4)	15C-19	15C-19	15C-19
+*13	Metering-Diaphragm	237-653	237-601	237-601
+*14	Metering-Diaphragm Gasket	16B-226	16B-226	16B-226
*15	Metering-By Pass Chamber Welch Plug (Large)	179-59	179-59	179-59
*16	Metering-Main Nozzle Welch Plug (Small)			
*17	Metering-Main Nozzle Screen			
18	Metering-Main Nozzle Screen Retaining Ring			
19	Metering-Nozzle Valve	363-518	363-528	363-544
20	Idle Speed-Adjustment Screw		15B-330	15B-330
21	Idle Speed-Adjustment Screw Spring		24B-298	24B-298
B1	Idle Speed-Adjustment Screw Cup			
22	Low Speed-Mixture Needle	43A-70	43A-28	43A-21
23	Low Speed-Mixture Needle Spring	24B-331	24B-331	24B-331
24	High Speed-Mixture Needle	43A-108	43A-121	43A-45
25	High Speed-Mixture Needle Spring	24B-449	24B-449	24B-449
26	High Speed-Governor Valve			361-512
27	High Speed-Governor Valve Gasket			16B-204
A1	Choke-Shaft & Lever		26-1264	
A4	Choke-Shaft & Lever	26-1041		
A15	Choke-Shaft & Lever			26-1135
28	Choke-Friction Spring	24B-281	24B-281	24B-281
29	Choke-Friction Ball	206-121	206-121	206-121
30	Choke-Shutter	27-331	27-331	27-310
31	Choke-Shutter Screw	15C-20	15C-20	15C-20
( B2 )	Choke-Shaft Cover			
( B3 )	Choke-Shaft Sleeve			
A3	Throttle-Shaft & Lever	13-1661	13-1944	
A7	Throttle-Shaft & Lever			13-1695
32	Throttle-Return Spring	24B-322	24B-360	24B-326
33	Throttle-Clip	29-224		29-224
34	Throttle-Clip Retaining Screw	15C-20		15C-20
35	Throttle-Shaft Washer		78A-226	
36	Throttle-Shaft E-Ring		29-220	
37	Throttle-Shutter	14-445	14A-12	14-430
38	Throttle-Shutter Screw	15C-20	15C-20	15C-20
B3	Throttle-Shaft Sleeve (2)		102-204	
*39	Flange Gasket	16B-249	16B-249	16B-228
	Repair Kit	RK-21HS	RK-24HS	RK-23HS
	Diaphragm & Gasket Set	DG-3HS/T	DG-2HS/T	DG-5HS/T

\*Indicates contents of Repair Kit

+Indicates contents of Diaphragm & Gasket Set

Carburetor Model		HS-158F	HS-163A	HS-172B
Customer		Alpina	Husqvarna	Partner
Equipment Model No.		070 Tendimatic/ A-70	61/162SE,SG/170, 266SE,	P-55/P-70/P-85/P-100
Venturi		C-70/CP-70/PROF-70	SG/PARTNER K12/R-12	P-1020/PM-1000/R-421T
Ref. No.		9/16"-14.3 MM	5/8"-15.9 MM	11/16"-17.5 MM
Ref. No.	Part Name			
1	Fuel Pump-Cover	91A-273	91A-273	91A-273
2	Fuel Pump-Cover Screw (4)	15C-30	15C-30	15C-30
+*3	Fuel Pump-Gasket	16B-227	16B-227	16B-227
+*4	Fuel Pump-Diaphragm	237-143	237-144	237-144
*5	Fuel Pump-Inlet Screen	95-177	95-177	95-177
*6	Fuel Inlet-Needle	34-216	34-216	34-216
*7	Fuel Inlet-Control Lever	155A-26	155A-26	155A-26
8	Fuel Inlet-Fulcrum Pin	32-78	32-78	32-78
9	Fuel Inlet-Fulcrum Pin Retaining Screw	15B-345	15B-345	15B-345
10	Fuel Inlet-Tension Spring	24B-299	24B-299	24B-299
B5	Fuel Inlet-Seat	36A-33		
11	Metering-Cover	91A-274	91B-223	91A-302
12	Metering-Cover Screw (4)	15C-19	15C-19	15C-19
+*13	Metering-Diaphragm	237-601	237-601	237-601
+*14	Metering-Diaphragm Gasket	16B-226	16B-226	16B-226
*15	Metering-By Pass Chamber Welch Plug (Large)	179-59	179-59	179-59
*16	Metering-Main Nozzle Welch Plug (Small)	179-60	179-60	
*17	Metering-Main Nozzle Screen	95-180	95-180	
18	Metering-Main Nozzle Screen Retaining Ring	55A-212	55A-212	
19	Metering-Nozzle Valve			363-518
20	Idle Speed-Adjustment Screw	15B-330		15C-21
21	Idle Speed-Adjustment Screw Spring	24B-298		
B1	Idle Speed-Adjustment Screw Cup			206-123
B6	Idle Speed-Adjustment Screw Retainer			
22	Low Speed-Mixture Needle	43A-28	43A-70	43A-9
23	Low Speed-Mixture Needle Spring	24B-331	24B-331	24B-450
24	High Speed-Mixture Needle	43A-156	43A-71	43A-10
25	High Speed-Mixture Needle Spring	24B-449	24B-449	24B-449
26	High Speed-Governor Valve			361-525
27	High Speed-Governor Valve Gasket			16B-204
A1	Choke-Shaft & Lever	26-1264		
A2	Choke-Shaft & Lever			26-1193
A4	Choke-Shaft & Lever		26-1212	
28	Choke-Friction Spring	24B-281	24B-281	24B-281
29	Choke-Friction Ball	206-121	206-121	206-121
30	Choke-Shutter	27-331	27-331	27-331
31	Choke-Shutter Screw	15C-20	15C-20	15C-20
(B2)	Choke-Shaft Cover			
(B3)	Choke-Shaft Sleeve			
A3	Throttle-Shaft & Lever	13-1944		
A5	Throttle-Shaft & Lever		13-2011	
A9	Throttle Shaft & Lever			13-1932
A18	Throttle-Shaft & Lever			
32	Throttle-Return Spring	24B-360	24B-434	24B-447
33	Throttle-Clip			
34	Throttle-Clip Retaining Screw			
35	Throttle-Shaft Washer	78A-226	78A-226	78A-226
36	Throttle-Shaft E-Ring	29-220	29-220	29-220
37	Throttle-Shutter	14-476	14-431	14-12
38	Throttle-Shutter Screw	15C-20	15C-20	15C-20
B3	Throttle-Shaft Sleeve	102-204	102-204	102-204
*39	Flange Gasket	16B228	16B228	16B-249
	Repair Kit	RK-24HS	RK-23HS	RK-23HS
	Diaphragm & Gasket Set	DG-2HS/T	DG-5HS/T	DG-5HS/T

\*Indicates contents of Repair Kit

+Indicates contents of Diaphragm & Gasket Set

Carburetor Model		HS-175D	HS-175G	HS-175H
Customer		Partner	Partner	Partner
Equipment Model No.		K-65/K-650/K-1200		
		K-1200-12/K-1200-14	K650	K650
Venturi		11/16"-17.5 MM		
Ref. No.	Part Name			
1	Fuel Pump-Cover	91A-273	91A-273	91A-273
2	Fuel Pump-Cover Screw (4)	15C-30	15C-30	15C-30
+*3	Fuel Pump-Gasket	16B-227	16B-227	16B-227
+*4	Fuel Pump-Diaphragm	237-144	237-144	237-144
*5	Fuel Pump-Inlet Screen	95-177	95-177	95-177
*6	Fuel Inlet-Needle	34-216	34-219	34-219
*7	Fuel Inlet-Control Lever	155A-26	155A-26	155A-26
8	Fuel Inlet-Fulcrum Pin	32-78	32-78	32-78
9	Fuel Inlet-Fulcrum Pin Retaining Screw	15B-345	15B-345	15B-345
10	Fuel Inlet-Tension Spring	24B-299	24B-299	24B-299
B5	Fuel Inlet-Seat	36A-33	36-A39	36A-39
11	Metering-Cover	91A-302	91B-223	91B-223
12	Metering-Cover Screw (4)	15C-19	15C-54	15C-54
+*13	Metering-Diaphragm	237-601	237-687	237-687
+*14	Metering-Diaphragm Gasket	16B-226	16B-390	16B-390
*15	Metering-By Pass Chamber Welch Plug (Large)	179-59	179-59	179-59
*16	Metering-Main Nozzle Welch Plug (Small)		179-60	179-60
*17	Metering-Main Nozzle Screen			
18	Metering-Main Nozzle Screen Retaining Ring			
19	Metering-Nozzle Valve	363-598	363-598	363-598
20	Idle Speed-Adjustment Screw	15C-21	15C-21	15C-21
21	Idle Speed-Adjustment Screw Spring			
B1	Idle Speed-Adjustment Screw Cup			
B6	Idle Speed-Adjustment Screw Retainer	55A-305	55A-305	55A-305
22	Low Speed-Mixture Needle	43A-70	43A-70	49B-77
23	Low Speed-Mixture Needle Spring	24B-450	24B-450	
24	High Speed-Mixture Needle	43A-71	43A-71	49-X-21
25	High Speed-Mixture Needle Spring	24B-449	24B-449	
26	High Speed-Governor Valve	361-505	361-505	361-542
27	High Speed-Governor Valve Gasket	16B-204	16B-204	16B-204
A4	Choke-Shaft & Lever			
A12	Choke-Shaft & Lever	26-1193	26-1298	26-1307
28	Choke-Friction Spring	24B-281	24B-281	24B-281
29	Choke-Friction Ball	206-121	206-121	206-121
30	Choke-Shutter	27-331	27-369	27-369
31	Choke-Shutter Screw	15C-20	15C-20	15C-20
A3	Throttle-Shaft & Lever			
A7	Throttle-Shaft & Lever			
A11	Throttle-Shaft & Lever	13-1932	13-1932	13-1932
A13	Throttle-Shaft & Lever			
32	Throttle-Return Spring	24B-447	24B-447	24B-447
33	Throttle-Clip			
34	Throttle-Clip Retaining Screw			
35	Throttle-Shaft Washer	78A-280	78A-280	78A-280
36	Throttle-Shaft E-Ring	29-220	29-220	29-220
37	Throttle-Shutter	14A-12	14A-12	14A-12
38	Throttle-Shutter Screw	15C-20	15C-20	15C-20
B3	Throttle-Shaft Sleeve	102-204	102-204	102-204
B7	Throttle-Shaft Quod Rings (2)	44-277	44-277	44-277
B7	Throttle-Shaft Quod Ring Wahser	78A-344	78A-344	78A-344
*39	Flange Gasket	16B-249		
	Repair Kit	RK-23HS	RK-32HS	RK-32HS
	Diaphragm & Gasket Set	DG-5HS/T	DG-10HS	DG-10HS

\*Indicates contents of Repair Kit

+Indicates contents of Diaphragm & Gasket Set

Carburetor Model		HS-175K	
Customer			
Equipment Model No.			
Venturi			
Ref. No.	Part Name		
1	Fuel Pump-Cover	91A-273	
2	Fuel Pump-Cover Screw (4)	15C-30	
+*3	Fuel Pump-Gasket	16B-227	
+*4	Fuel Pump-Diaphragm	237-144	
*5	Fuel Pump-Inlet Screen	95-177	
*6	Fuel Inlet-Needle	34-219	
*7	Fuel Inlet-Control Lever	155A-26	
8	Fuel Inlet-Fulcrum Pin	32-78	
9	Fuel Inlet-Fulcrum Pin Retaining Screw	15B-345	
10	Fuel Inlet-Tension Spring	24B-299	
B5	Fuel Inlet-Seat	36A-39	
11	Metering-Cover	91B-260	
12	Metering-Cover Screw (4)	15C-54	
+*13	Metering-Diaphragm	237-601	
+*14	Metering-Diaphragm Gasket	16B-226	
*15	Metering-By Pass Chamber Welch Plug (Large)	179-59	
*16	Metering-Main Nozzle Welch Plug (Small)	179-60	
*17	Metering-Main Nozzle Screen		
18	Metering-Main Nozzle Screen Retaining Ring		
19	Metering-Nozzle Valve	363-598	
20	Idle Speed-Adjustment Screw	15C-21	
21	Idle Speed-Adjustment Screw Spring		
B1	Idle Speed-Adjustment Screw Cup		
B6	Idle Speed-Adjustment Screw Retainer	55A-305	
22	Low Speed-Mixture Needle	49B-77	
23	Low Speed-Mixture Needle Spring		
24	High Speed-Mixture Needle		
25	High Speed-Mixture Needle Spring		
26	High Speed-Governor Valve	361-542	
27	High Speed-Governor Valve Gasket	16B-204	
A4	Choke-Shaft & Lever		
A12	Choke-Shaft & Lever	26-1307	
28	Choke-Friction Spring	24B-281	
29	Choke-Friction Ball	206-121	
30	Choke-Shutter	27-369	
31	Choke-Shutter Screw	15C-20	
A3	Throttle-Shaft & Lever		
A7	Throttle-Shaft & Lever		
A11	Throttle-Shaft & Lever	13-1932	
A13	Throttle-Shaft & Lever		
32	Throttle-Return Spring	24B-447	
33	Throttle-Clip		
34	Throttle-Clip Retaining Screw		
35	Throttle-Shaft Washer	78A-280	
36	Throttle-Shaft E-Ring	29-220	
37	Throttle-Shutter	14A-12	
38	Throttle-Shutter Screw	15C-20	
B3	Throttle-Shaft Sleeve	102-204	
B7	Throttle-Shaft Quod Rings (2)	44-277	
		78A-344	
*39	Flange Gasket		
	Repair Kit	RK-32HS	
	Diaphragm & Gasket Set	DG-10HS	

\*Indicates contents of Repair Kit

+Indicates contents of Diaphragm & Gasket Set

Carburetor Model		HS-179B	HS-181C	
Customer		Homelite	Andreas Stihl	
Equipment Model No.		SXL-Auto/XL-12	0-41 FB	
Venturi		XL-Auto		
		9/16"-14.3 MM	9/16"-14.3 MM	
Ref. No.	Part Name			
1	Fuel Pump-Cover	91A-273	91-761	
2	Fuel Pump-Cover Screw (4)	15C-30	15C-30	
+*3	Fuel Pump-Gasket	16B-227	16B-227	
+*4	Fuel Pump-Diaphragm	237-144	237-144	
*5	Fuel Pump-Inlet Screen	95-177	95-177	
*6	Fuel Inlet-Needle	34-216	34-216	
*7	Fuel Inlet-Control Lever	155A-26	155A-26	
8	Fuel Inlet-Fulcrum Pin	32-78	32-78	
9	Fuel Inlet-Fulcrum Pin Retaining Screw	15B-345	15B-345	
10	Fuel Inlet-Tension Spring	24B-323	24B-299	
B5	Fuel Inlet-Seat			
11	Metering-Cover	91A-274	91A-295	
12	Metering-Cover Screw (4)	15C-19	15C-19	
+*13	Metering-Diaphragm	237-601	237-653	
+*14	Metering-Diaphragm Gasket	16B-226	16B-226	
*15	Metering-By Pass Chamber Welch Plug (Large)	179-59	179-59	
*16	Metering-Main Nozzle Welch Plug (Small)	179-60	179-60	
*17	Metering-Main Nozzle Screen	95-180	95-180	
18	Metering-Main Nozzle Screen Retaining Ring	55A-212	55A-212	
19	Metering-Nozzle Valve			
20	Idle Speed-Adjustment Screw			
21	Idle Speed-Adjustment Screw Spring			
B1	Idle Speed-Adjustment Screw Cup			
B6	Idle Speed-Adjustment Screw Retainer			
22	Low Speed-Mixture Needle	43-417	43A-70	
23	Low Speed-Mixture Needle Spring	24B-449	24B-331	
24	High Speed-Mixture Needle	43-418	43A-71	
25	High Speed-Mixture Needle Spring	24B-449	24B-449	
26	High Speed-Governor Valve			
27	High Speed-Governor Valve Gasket			
A4	Choke-Shaft & Lever			
A12	Choke-Shaft & Lever			
28	Choke-Friction Spring	26-1149	26-1041	
29	Choke-Friction Ball	24B-281	24B-281	
30	Choke-Shutter	206-121	206-121	
31	Choke-Shutter Screw	27-310	27-331	
			15C-20	
A3	Throttle-Shaft & Lever			
A7	Throttle-Shaft & Lever	13-1876		
A11	Throttle-Shaft & Lever			
A13	Throttle-Shaft & Lever		13-1950	
32	Throttle-Return Spring	24B-326	24B-322	
33	Throttle-Clip			
34	Throttle-Clip Retaining Screw			
35	Throttle-Shaft Washer	78A-226		
36	Throttle-Shaft E-Ring	29-220	29-220	
37	Throttle-Shutter	14-471	14-471	
38	Throttle-Shutter Screw	15C-20	15C-20	
B3	Throttle-Shaft Sleeve			
B7	Throttle-Shaft Quod Rings (2)			
B7	Throttle-Shaft Quod Ring Washer			
*39	Flange Gasket	16B-228	16B-228	
	Repair Kit	RK-23HS	RK-21HS	
	Diaphragm & Gasket Set	DG-5HS/T	DG-3HS/T	

\*Indicates contents of Repair Kit

+Indicates contents of Diaphragm & Gasket Set

Carburetor Model		HS-182C	HS-187A	HS-195A
Customer		Sachs Dolmar	Sachs Dolmar	Homelite
Equipment Model No.		309 Power Cutter	123	XL-12
Venturi		11/16"-17.5 MM	11/16"-17.5 MM	9/16"-14.3 MM
Ref. No.	Part Name			
1	Fuel Pump-Cover	91A-273	91A-273	91A-273
2	Fuel Pump-Cover Screw (4)	15C-30	15C-30	15C-30
+*3	Fuel Pump-Gasket	16B-227	16B-227	16B-227
+*4	Fuel Pump-Diaphragm	237-144	237-144	237-144
*5	Fuel Pump-Inlet Screen	95-177	95-177	95-177
*6	Fuel Inlet-Needle	34-216	34-216	34-216
*7	Fuel Inlet-Control Lever	155A-26	155A-26	155A-26
8	Fuel Inlet-Fulcrum Pin	32-78	32-78	32-78
9	Fuel Inlet-Fulcrum Pin Retaining Screw	15B-345	15B-345	15B-345
10	Fuel Inlet-Tension Spring	24B-323	24B-323	24B-323
B5	Fuel Inlet-Seat			
11	Metering-Cover	91A-352	91A-352	91A-274
12	Metering-Cover Screw (4)	15C-19	15C-19	15C-19
+*13	Metering-Diaphragm	237-601	237-601	237-601
+*14	Metering-Diaphragm Gasket	16B-226	16B-226	16B-226
*15	Metering-By Pass Chamber Welch Plug (Large)	179-59	179-59	179-59
*16	Metering-Main Nozzle Welch Plug (Small)		179-60	
*17	Metering-Main Nozzle Screen		95-180	
18	Metering-Main Nozzle Screen Retaining Ring		55A-212	
19	Metering-Nozzle Valve	363-581		363-544
20	Idle Speed-Adjustment Screw	15B-330	15B-330	
21	Idle Speed-Adjustment Screw Spring	24B-298	24B-298	
B1	Idle Speed-Adjustment Screw Cup			
22	Low Speed-Mixture Needle	43A-70	43A-70	43-417
23	Low Speed-Mixture Needle Spring	24B-331	24B-331	24B-449
24	High Speed-Mixture Needle		43A-71	
25	High Speed-Mixture Needle Spring		24B-449	
26	High Speed-Governor Valve	361-534	361-525	
27	High Speed-Governor Valve Gasket	16B-204	16B-204	
A4	Choke-Shaft & Lever	26-1288	26-1037	26-1149
A14	Choke-Shaft & Lever			
28	Choke-Friction Spring	24B-281	24B-281	24B-281
29	Choke-Friction Ball	206-121	206-121	206-121
30	Choke-Shutter	27-331	27-331	27-310
31	Choke-Shutter Screw	15C-20	15C-20	
A3	Throttle-Shaft & Lever	13-1944	13-1944	
A6	Throttle-Shaft & Lever			
A7	Throttle-Shaft & Lever			13-1876
A10	Throttle-Shaft & Lever			
A13	Throttle-Shaft & Lever			
C1	Throttle-Lever			
B3	Throttle-Shaft Sleeve	102-204	102-204	
B4	Throttle-Lever Retaining Screw			
32	Throttle-Return Spring	24B-435	24B-435	24B-326
33	Throttle-Clip			
34	Throttle-Clip Retaining Screw			
35	Throttle-Shaft Washer	78A-226	78A-226	78A-226
36	Throttle-Shaft E-Ring	29-220	29-220	29-220
37	Throttle-Shutter	14-445	14-445	14-471
38	Throttle-Shutter Screw	15C-20	15C-20	15C-20
B7	Throttle-Shaft Sleeve (2)	102-204		
*39	Flange Gasket	16B-249	16B-249	16B-228
	Repair Kit	RK-23HS	RK-23HS	RK-23HS
	Diaphragm & Gasket Set	DG-5HS/T	DG-5HS/T	DG-5HS/T

\*Indicates contents of Repair Kit

+Indicates contents of Diaphragm & Gasket Set

Carburetor Model		HS-203E	HS-205A
Customer		Sachs-Dolmar	Husqvarna
Equipment Model No.		133	480 CD
Venturi		11/16"-17.5 MM	11/16"-17.5 MM
Ref. No.	Part Name		
1	Fuel Pump-Cover	91A-273	91A-273
2	Fuel Pump-Cover Screw (4)	15C-30	15C-30
+*3	Fuel Pump-Gasket	16B-227	16B-227
+*4	Fuel Pump-Diaphragm	237-144	237-144
*5	Fuel Pump-Inlet Screen	95-177	95-177
*6	Fuel Inlet-Needle	34-216	34-216
*7	Fuel Inlet-Control Lever	155A-26	155A-26
8	Fuel Inlet-Fulcrum Pin	32-78	32-78
9	Fuel Inlet-Fulcrum Pin Retaining Screw	15B-345	15B-345
10	Fuel Inlet-Tension Spring	24B-323	24B-299
11	Metering-Cover	91A-352	91A-274
12	Metering-Cover Screw (4)	15C-19	15C-19
+*13	Metering-Diaphragm	237-601	237-601
+*14	Metering-Diaphragm Gasket	16B-226	16B-226
*15	Metering-By Pass Chamber Welch Plug (Large)	179-59	179-59
*16	Metering-Main Nozzle Welch Plug (Small)	179-60	179-60
*17	Metering-Main Nozzle Screen	95-180	95-180
18	Metering-Main Nozzle Screen Retaining Ring	55A-212	55A-212
19	Metering-Nozzle Valve		
20	Idle Speed-Adjustment Screw	15C-23	15B-330
21	Idle Speed-Adjustment Screw Spring		24B-298
B1	Idle Speed-Adjustment Screw Cup		318-18
B6	Idle Speed-Adjustment Screw Retainer	206-123	
22	Low Speed-Mixture Needle	43A-19	43A-70
23	Low Speed-Mixture Needle Spring	24B-331	24B-331
24	High Speed-Mixture Needle	43A-20	43A-71
25	High Speed-Mixture Needle Spring	24B-449	24B-449
26	High Speed-Governor Valve	361-529	
27	High Speed-Governor Valve Gasket	16B-204	
A1	Choke-Shaft & Lever		
A4	Choke-Shaft & Lever	26-1272	26-1212
A15	Choke-Shaft & Lever		
28	Choke-Friction Spring	24B-281	24B-281
29	Choke-Friction Ball	206-121	206-121
30	Choke-Shutter	27-331	27-331
31	Choke-Shutter Screw	15C-20	15C-20
B2	Choke-Shaft Cover		
B3	Choke-Shaft Sleeve		
B8	Choke-Shaft O-Ring		
A1	Throttle-Shaft & Lever		
A3	Throttle-Shaft & Lever		13-2096
A20	Throttle-Shaft & Lever	13-1956	
32	Throttle-Return Spring	24C-29	24B-437
33	Throttle-Clip		
34	Throttle-Clip Retaining Screw		
35	Throttle-Shaft Washer	78A-226	78A-280
36	Throttle-Shaft E-Ring	29-220	29-220
37	Throttle-Shutter	14-445	14-445
38	Throttle-Shutter Screw	15C-20	15C-20
B3	Throttle-Shaft Sleeve	102-204	102-204
B7	Throttle-Shaft Quod Ring		
*39	Flange Gasket	16B-249	16B-228
	Repair Kit	RK-23HS	RK-23HS
	Diaphragm & Gasket Set	DG-5HS/T	DG-5HS/T

\*Indicates contents of Repair Kit

+Indicates contents of Diaphragm & Gasket Set



Carburetor Model		HS-212B	HS-213A
Customer		Andreas Stihl	Pioneer
Equipment Model No.			P61/P615
Venturi		11/16"-17.5 MM	5/8"-15.9 MM
Ref. No.	Part Name		
1	Fuel Pump-Cover	91-761	91A-273
2	Fuel Pump-Cover Screw (4)	15C-30	15C-30
+*3	Fuel Pump-Gasket	16B-227	16B-227
+*4	Fuel Pump-Diaphragm	237-144	237-144
*5	Fuel Pump-Inlet Screen	95-177	95-177
*6	Fuel Inlet-Needle	34-216	34-216
*7	Fuel Inlet-Control Lever	155A-71	155A-26
8	Fuel Inlet-Fulcrum Pin	32-78	32-78
9	Fuel Inlet-Fulcrum Pin Retaining Screw	15B-345	15B-345
10	Fuel Inlet-Tension Spring	24B-299	24B-323
11	Metering-Cover	91B-191	91A-274
12	Metering-Cover Screw (4)	15C-19	15C-19
+*13	Metering-Diaphragm	237-653	237-601
+*14	Metering-Diaphragm Gasket	16B-226	16B-226
*15	Metering-By Pass Chamber Welch Plug (Large)	179-59	179-59
*16	Metering-Main Nozzle Welch Plug (Small)		179-60
*17	Metering-Main Nozzle Screen		95-180
18	Metering-Main Nozzle Screen Retaining Ring		55A-212
19	Metering-Nozzle Valve	363-518	
20	Idle Speed-Adjustment Screw		15B-330
21	Idle Speed-Adjustment Screw Spring		24B-298
B1	Idle Speed-Adjustment Screw Cup		
B6	Idle Speed-Adjustment Screw Retainer		
22	Low Speed-Mixture Needle	43A-70	43A-33
23	Low Speed-Mixture Needle Spring	24B-331	24B-331
24	High Speed-Mixture Needle	43A-108	43A-34
25	High Speed-Mixture Needle Spring	24B-449	24B-449
26	High Speed-Governor Valve	361-507	361-512
27	High Speed-Governor Valve Gasket	16B-204	16B-204
A1	Choke-Shaft & Lever		
A3	Choke-Shaft & Lever		26-1169
A4	Choke-Shaft & Lever		
A5	Choke-Shaft & Lever	26-1041	
28	Choke-Friction Spring	24B-281	24B-281
29	Choke-Friction Ball	206-121	206-121
30	Choke-Shutter	27-331	27-331
31	Choke-Shutter Screw	15C-20	15C-20
A1	Throttle-Shaft & Lever		13-1838
A3	Throttle-Shaft & Lever	13-1661	
32	Throttle-Return Spring	24B-322	24B-420
33	Throttle-Clip	29-224	29-224
34	Throttle-Clip Retaining Screw	15C-20	15B-414
35	Throttle-Shaft Washer		
36	Throttle-Shaft E-Ring		
37	Throttle-Shutter	14-445	14-458
38	Throttle-Shutter Screw	15C-20	15C-20
B3	Throttle-Shaft Sleeve		102-204
*39	Flange Gasket	16B-249	16B-228
	Repair Kit	RK-21HS	RK-23HS
	Diaphragm & Gasket Set	DG-3HS/T	DG-5HS/T

\*Indicates contents of Repair Kit

+Indicates contents of Diaphragm & Gasket Set

Carburetor Model		HS-216C	HS-218A	HS-219C
Customer		Husqvarna	Jonsereds	Jonsereds
Equipment Model No.		181/181SE/181SG	630	820/830/920/930
Venturi		11/16"-17.5 MM	5/8"-15.9 MM	11/16"-17.5 MM
Ref. No.	Part Name			
1	Fuel Pump-Cover	91A-273	91A-273	91-974
2	Fuel Pump-Cover Screw (4)	15C-30	15C-30	15C-30
+*3	Fuel Pump-Gasket	16B-227	16B-227	16B-227
+*4	Fuel Pump-Diaphragm	237-144	237-144	237-144
*5	Fuel Pump-Inlet Screen	95-177	95-177	95-177
*6	Fuel Inlet-Needle	34-216	34-216	34-216
*7	Fuel Inlet-Control Lever	155A-26	155A-26	155A-26
8	Fuel Inlet-Fulcrum Pin	32-78	32-78	32-78
9	Fuel Inlet-Fulcrum Pin Retaining Screw	15B-345	15B-345	15B-345
10	Fuel Inlet-Tension Spring	24B-299	24B-299	24B-323
11	Metering-Cover	91A-274	91A-274	91A-274
12	Metering-Cover Screw (4)	15C-19	15C-19	15C-19
+*13	Metering-Diaphragm	237-601	237-601	237-601
+*14	Metering-Diaphragm Gasket	16B-226	16B-226	16B-226
*15	Metering-By Pass Chamber Welch Plug (Large)	179-59	179-59	179-59
*16	Metering-Main Nozzle Welch Plug (Small)	179-60	179-60	179-60
*17	Metering-Main Nozzle Screen	95-180	95-180	95-180
18	Metering-Main Nozzle Screen Retaining Ring	55A-212	55A-212	55A-212
19	Metering-Nozzle Valve			
20	Idle Speed-Adjustment Screw			15C-21
21	Idle Speed-Adjustment Screw Spring			
B1	Idle Speed-Adjustment Screw Cup			206-123
22	Low Speed-Mixture Needle	43A-70	43A-70	43A-70
23	Low Speed-Mixture Needle Spring	24B-331	24B-331	24B-331
24	High Speed-Mixture Needle	43A-71	43A-71	43A-71
25	High Speed-Mixture Needle Spring	24B-449	24B-449	24B-449
26	High Speed-Governor Valve	361-530		
27	High Speed-Governor Valve Gasket	16B-204		
B9	High Speed-Governor Valve Anti Surge Orifice	78A-335		
C2	Choke-Lever			
C3	Choke-Lever		25-469	25-469
A4	Choke-Shaft & Lever	26-1212		
A21	Choke-Shaft & Lever		26-1260	26-1260
28	Choke-Friction Spring	24B-281		
29	Choke-Friction Ball	206-121		
30	Choke-Shutter	27-331	27-331	27-331
31	Choke-Shutter Screw	15C-20	15C-20	15C-20
B10	Choke-Shaft Return Spring			
A5	Throttle-Shaft & Lever	13-2011	24C-141	24C-141
	Throttle-Shaft & Lever		13-2012	
A13	Throttle-Shaft & Lever			
A20	Throttle-Shaft & Lever			13-1995
32	Throttle-Return Spring	24B-434	24B-434	24C-29
33	Throttle-Clip			
34	Throttle-Clip Retaining Screw			
35	Throttle-Shaft Washer	78A-226	78A-226	78A-226
36	Throttle-Shaft E-Ring	29-220	29-220	29-220
37	Throttle-Shutter	14-445	14-431	14-445
38	Throttle-Shutter Screw	15C-20	15C-20	15C-20
B3	Throttle-Shaft Sleeve	102-204	102-204	102-204
C2	Throttle-Lever		12B-363	12B-363
B4	Throttle-Lever Retaining Screw		15B-348	15B-348
*39	Flange Gasket	16B-228	16B-228	16B-249
	Repair Kit	RK-23HS	RK-23HS	RK-23HS
	Diaphragm & Gasket Set	DG-5HS/T	DG-5HS/T	DG-5HS/T

\*Indicates contents of Repair Kit

+Indicates contents of Diaphragm & Gasket Set



Carburetor Model		HS-224A	HS-225A
Customer		Husqvarna	Jonsereds
Equipment Model No.		H66/H266/366	630
Venturi		11/16"-17.5 MM	11/16"-17.5 MM
Ref. No.	Part Name		
1	Fuel Pump-Cover	91A-273	91A-273
2	Fuel Pump-Cover Screw (4)	15C-30	15C-30
+*3	Fuel Pump-Gasket	16B-227	16B-227
+*4	Fuel Pump-Diaphragm	237-144	237-144
*5	Fuel Pump-Inlet Screen	95-177	95-177
*6	Fuel Inlet-Needle	34-216	34-216
*7	Fuel Inlet-Control Lever	155A-26	155A-26
8	Fuel Inlet-Fulcrum Pin	32-78	32-78
9	Fuel Inlet-Fulcrum Pin Retaining Screw	15B-345	15B-345
10	Fuel Inlet-Tension Spring	24B-299	24B-323
11	Metering-Cover	91B-223	91A-274
12	Metering-Cover Screw (4)	15C-19	15C-19
+*13	Metering-Diaphragm	237-601	237-601
+*14	Metering-Diaphragm Gasket	16B-226	16B-226
*15	Metering-By Pass Chamber Welch Plug (Large)	179-59	179-59
*16	Metering-Main Nozzle Welch Plug (Small)	179-60	179-60
*17	Metering-Main Nozzle Screen	95-180	95-180
18	Metering-Main Nozzle Screen Retaining Ring	55A-212	55A-212
19	Metering-Nozzle Valve		
20	Idle Speed-Adjustment Screw		
21	Idle Speed-Adjustment Screw Spring		
B1	Idle Speed-Adjustment Screw Cup		
22	Low Speed-Mixture Needle	43A-70	43A-70
23	Low Speed-Mixture Needle Spring	24B-331	24B-331
24	High Speed-Mixture Needle	43A-71	43A-71
25	High Speed-Mixture Needle Spring	24B-449	24B-449
26	High Speed-Governor Valve		
27	High Speed-Governor Valve Gasket		
C3	Choke-Lever		25-469
A4	Choke-Shaft & Lever	26-1212	
A21	Choke-Shaft & Lever		26-1260
28	Choke-Friction Spring	24B-281	
29	Choke-Friction Ball	206-121	
30	Choke-Shutter	27-331	27-331
31	Choke-Shutter Screw	15C-20	15C-20
B10	Choke-Shaft Return Spring		24C-141
A3	Throttle-Shaft & Lever		
A5	Throttle-Shaft & Lever	13-2011	13-2012
A20	Throttle-Shaft & Lever		
32	Throttle-Return Spring	24B-434	24B-434
33	Throttle-Clip		
34	Throttle-Clip Retaining Screw		
35	Throttle-Shaft Washer	78A-226	78A-226
36	Throttle-Shaft E-Ring	29-220	29-220
37	Throttle-Shutter	14-445	14-445
38	Throttle-Shutter Screw	15C-20	15C-20
B3	Throttle-Shaft Sleeve	102-204	102-204
C2	Throttle-Lever		12B-363
B4	Throttle-Lever Retaining Screw		15B-348
*39	Flange Gasket	16B-228	16B-228
Repair Kit		RK-23HS	RK-23HS
Diaphragm & Gasket Set		DG-5HS/T	DG-5HS/T

\*Indicates contents of Repair Kit

+Indicates contents of Diaphragm & Gasket Set

Carburetor Model		HS-228C	HS-230D	HS-232C
Customer		Husqvarna	Jonsereds	Sachs-Dolmar
Equipment Model No.		281	J-670	SD 143
Venturi		11/16"-17.5 MM	11/16"-17.5 MM	11/16"-17.5 MM
Ref. No.	Part Name			
1	Fuel Pump-Cover	91A-273	91-996	91A-273
2	Fuel Pump-Cover Screw (4)	15C-30	15C-30	15C-30
+*3	Fuel Pump-Gasket	16B-227	16B-227	16B-227
+*4	Fuel Pump-Diaphragm	237-144	237-144	237-143
*5	Fuel Pump-Inlet Screen	95-177	95-177	95-177
*6	Fuel Inlet-Needle	34-216	34-216	34-216
*7	Fuel Inlet-Control Lever	155A-26	155A-26	155A-26
8	Fuel Inlet-Fulcrum Pin	32-78	32-78	32-78
9	Fuel Inlet-Fulcrum Pin Retaining Screw	15B-345	15B-345	15B-345
10	Fuel Inlet-Tension Spring	24B-299	24B-323	24B-323
B5	Fuel Inlet-Seat			
11	Metering-Cover	91B-223	91A-274	91A-352
12	Metering-Cover Screw (4)	15C-19	15C-19	15C-19
+*13	Metering-Diaphragm	237-601	237-601	237-601
+*14	Metering-Diaphragm Gasket	16B-226	16B-226	16B-226
*15	Metering-By Pass Chamber Welch Plug (Large)	179-59	179-59	179-59
*16	Metering-Main Nozzle Welch Plug (Small)		179-60	179-60
*17	Metering-Main Nozzle Screen		95-180	95-180
18	Metering-Main Nozzle Screen Retaining Ring		55A-212	55A-212
19	Metering-Nozzle Valve	363-629		
20	Idle Speed-Adjustment Screw		15C-21	15C-23
21	Idle Speed-Adjustment Screw Spring			
B1	Idle Speed-Adjustment Screw Cup			
B6	Idle Speed-Adjustment Screw Retainer		206-123	206-123
22	Low Speed-Mixture Needle	43A-70	43A-70	43A-19
23	Low Speed-Mixture Needle Spring		24B-449	24B-331
24	High Speed-Mixture Needle	43A-152	43A-152	43A-20
25	High Speed-Mixture Needle Spring	24B-331	24B-331	24B-449
26	High Speed-Governor Valve			361-530
27	High Speed-Governor Valve Gasket			16B-204
B9	High Speed-Governor Valve Anti Surge Orifice			
A4	Choke-Shaft & Lever	26-1212		26-1272
A21	Choke-Shaft & Lever		26-1260	
28	Choke-Friction Spring	24B-281		24B-281
29	Choke-Friction Ball	206-121		206-121
30	Choke-Shutter	27-331	27-331	27-331
31	Choke-Shutter Screw	15C-20	15C-20	15C-20
B10	Choke-Shaft Return Spring		24C-141	
C3	Choke-Lever		25-469	
A9	Throttle-Shaft & Lever		13-2040	
A20	Throttle-Shaft & Lever			13-1956
A22	Throttle-Shaft & Lever	13-2038		
32	Throttle-Return Spring	24B-434	24B-447	24C-29
35	Throttle-Shaft Washer	78A-226	78A-226	78A-226
36	Throttle-Shaft E-Ring	29-220	29-220	29-220
37	Throttle-Shutter	14-445	14-445	14-445
38	Throttle-Shutter Screw	15C-20	15C-20	15C-20
B3	Throttle-Shaft Sleeve	102-204	102-204	102-204
C2	Throttle-Lever		12B-363	
B4	Throttle-Lever Retaining Screw		15B-348	
*39	Flange Gasket	16B-228		
	Repair Kit	RK-23HS	RK-23HS	RK-24HS
	Diaphragm & Gasket Set	DG-5HS	DG-5HS	DG-5HS

\*Indicates contents of Repair Kit

+Indicates contents of Diaphragm & Gasket Set

Carburetor Model		HS-234B	HS-235B	
Customer		Husqvarna	Wacker	
Equipment Model No.		268	BS-45Y/BS-60Y	
Venturi		11/16"-17.5 MM	9/16"-14.3 MM	
Ref. No.	Part Name			
1	Fuel Pump-Cover	91A-273	91-968	
2	Fuel Pump-Cover Screw (4)	15C-30	15C-30	
+*3	Fuel Pump-Gasket	16B-227	16B-227	
+*4	Fuel Pump-Diaphragm	237-144	237-144	
*5	Fuel Pump-Inlet Screen	95-177	95-188	
*6	Fuel Inlet-Needle	34-216	34-216	
*7	Fuel Inlet-Control Lever	155A-26	155A-26	
8	Fuel Inlet-Fulcrum Pin	32-78	32-78	
9	Fuel Inlet-Fulcrum Pin Retaining Screw	15B-345	15B-345	
10	Fuel Inlet-Tension Spring	24B-299	24B-299	
B5	Fuel Inlet-Seat			
11	Metering-Cover	91B-223	91B-253	
12	Metering-Cover Screw (4)	15C-19	15C-53	
+*13	Metering-Diaphragm	237-601	237-686	
+*14	Metering-Diaphragm Gasket	16B-226	16B-226	
*15	Metering-By Pass Chamber Welch Plug (Large)	179-59	179-59	
*16	Metering-Main Nozzle Welch Plug (Small)		179-60	
*17	Metering-Main Nozzle Screen		95-180	
18	Metering-Main Nozzle Screen Retaining Ring		55A-212	
19	Metering-Nozzle Valve	363-618		
20	Idle Speed-Adjustment Screw	15C-21		
21	Idle Speed-Adjustment Screw Spring	206-123		
B6	Idle Speed-Adjustment Screw Retainer			
22	Low Speed-Mixture Needle	43A-70	43-420	
23	Low Speed-Mixture Needle Spring	24B-331	24B-331	
24	High Speed-Mixture Needle	43A-152		
25	High Speed-Mixture Needle Spring	24B-331		
B7	High Speed-Sealing Screw Gasket		16B-184	
B11	High Speed-Sealing Screw		15C-14	
B12	High Speed-Jet		49A-441	
A1	Choke-Shaft & Lever		26-1262	
A4	Choke-Shaft & Lever	26-1266		
28	Choke-Friction Spring	24B-281	24B-281	
29	Choke-Friction Ball	206-121	206-121	
30	Choke-Shutter	27-331	27-342	
31	Choke-Shutter Screw	15C-20	15C-20	
B2	Choke-Shaft Cover		91B-208	
B3	Choke-Shaft Sleeve		102-204	
B8	Choke-Shaft O-Ring		44-296	
A13	Throttle-Shaft & Lever	13-2043		
A16	Throttle-Shaft & Lever		13-2037	
32	Throttle-Return Spring	24B-447	24B-435	
33	Throttle-Clip		29-224	
34	Throttle-Clip Retaining Screw		15C-20	
35	Throttle-Shaft Washer	78A-226		
36	Throttle-Shaft E-Ring	29-220		
37	Throttle-Shutter	14-445	14A-26	
38	Throttle-Shutter Screw	15C-20	15C-20	
B3	Throttle-Shaft Sleeve	102-204	102-204	
*39	Flange Gasket	16B228	16B228	
	Diaphragm & Gasket Set	RK-23HS	RK-26HS	
	Diaphragm & Gasket Set	DG-5HS/T	DG-8HS	

\*Indicates contents of Repair Kit

+Indicates contents of Diaphragm & Gasket Set

Carburetor Model		HS-236E	HS-237A	HS-239D
Customer		Sachs-Dolmar	Jonsereds	Sachs-Dolmar
Equipment Model No.		120 Super/121-S	625	392
		166 S		
Venturi		11/16"-17.5 MM	11/16"-17.5 MM	11/16"-17.5 MM
Ref. No.	Part Name			
1	Fuel Pump-Cover	91-1005	91-1008	91A-273
2	Fuel Pump-Cover Screw (4)	15C-30	15C-30	15C-30
+*3	Fuel Pump-Gasket	16B-227	16B-227	16B-227
+*4	Fuel Pump-Diaphragm	237-144	237-144	237-144
*5	Fuel Pump-Inlet Screen	95-177	95-177	95-177
*6	Fuel Inlet-Needle	34-216	34-216	34-216
*7	Fuel Inlet-Control Lever	155A-26	155A-26	155A-26
8	Fuel Inlet-Fulcrum Pin	32-78	32-78	32-78
9	Fuel Inlet-Fulcrum Pin Retaining Screw	15B-345	15B-345	15B-345
10	Fuel Inlet-Tension Spring	24B-345	24B-323	24B-323
B5	Fuel Inlet-Seat			
11	Metering-Cover	91B-235	91A-274	91A-352
12	Metering-Cover Screw (4)	15C-19	15C-19	15C-19
+*13	Metering-Diaphragm	237-601	237-601	237-601
+*14	Metering-Diaphragm Gasket	16B-226	16B-226	16B-226
*15	Metering-By Pass Chamber Welch Plug (Large)	179-59	179-59	179-59
*16	Metering-Main Nozzle Welch Plug (Small)	179-60	179-60	179-60
*17	Metering-Main Nozzle Screen	95-180	95-180	95-180
18	Metering-Main Nozzle Screen Retaining Ring	55A-212	55A-212	55A-212
19	Metering-Nozzle Valve			
20	Idle Speed-Adjustment Screw	15C-21	15C-21	15B-330
21	Idle Speed-Adjustment Screw Spring			24B-298
B1	Idle Speed-Adjustment Screw Cup			
B6	Idle Speed-Adjustment Screw Retainer	206-123	206-123	
22	Low Speed-Mixture Needle	43A-70	43A-70	43A-70
23	Low Speed-Mixture Needle Spring	24B-331	24B-331	24B-331
24	High Speed-Mixture Needle	43A-143	43A-120	
25	High Speed-Mixture Needle Spring	24B-449	24B-449	
26	High Speed-Governor Valve			361-506
27	High Speed-Governor Valve Gasket			16B-204
A4	Choke-Shaft & Lever			26-1288
A21	Choke-Shaft & Lever		26-1260	
B10	Choke-Shaft Return Spring		24C-141	
28	Choke-Friction Spring			24B-281
29	Choke-Friction Ball			206-121
30	Choke-Shutter		27-331	27-370
31	Choke-Shutter Screw		15C-20	15C-20
C3	Choke Lever		25-469	
A3	Throttle-Shaft & Lever			13-1944
A9	Throttle-Shaft & Lever		13-2040	
A20	Throttle-Shaft & Lever	13-1956		
32	Throttle-Return Spring	24C-29	24B-447	24B-435
33	Throttle-Clip			
34	Throttle-Clip Retaining Screw			
35	Throttle-Shaft Washer	78A-226	78A-226	78A-226
36	Throttle-Shaft E-Ring	29-220	29-220	29-220
37	Throttle-Shutter	14-431	14-445	14-445
38	Throttle-Shutter Screw	15C-20	15C-20	15C-20
B3	Throttle-Shaft Sleeve	102-204	102-204	102-204
B4	Throttle-Lever Retaining Screw		15B-348	
C2	Throttle-Lever			
*39	Flange Gasket	16B-249	16B-228	16B-249
	Repair Kit	RK-24HS	RK-23HS	RK-23HS
	Diaphragm & Gasket Set	DG-2HS/T	DG-5HS/T	DG-5HS/T
	Choke Valve	392-506		

\*Indicates contents of Repair Kit

+Indicates contents of Diaphragm & Gasket Set

Carburetor Model		HS-240C	HS-241A	HS-250A
Customer		Wacker	Fichtel & Sachs	Jonsereds
Equipment Model No.		BS-45/BS-60Y	Earth Compactor	J670
Venturi		11/16"-17.5 MM	9/16"-14.3 MM	11/16"-17.5 MM
Ref. No.	Part Name			
1	Fuel Pump-Cover	91A-273	91-985	91-996
2	Fuel Pump-Cover Screw (4)	15C-30	15C-30	15C-30
+*3	Fuel Pump-Gasket	16B-227	16B-227	16B-227
+*4	Fuel Pump-Diaphragm	237-144	237-144	237-144
*5	Fuel Pump-Inlet Screen	95-188	95-177	95-177
*6	Fuel Inlet-Needle	34-216	34-216	34-216
*7	Fuel Inlet-Control Lever	155A-26	155A-26	155A-26
8	Fuel Inlet-Fulcrum Pin	32-78	32-78	32-78
9	Fuel Inlet-Fulcrum Pin Retaining Screw	15B-345	15B-345	15B-345
10	Fuel Inlet-Tension Spring	24B-299	24B-299	24B-323
B5	Fuel Inlet-Seat			
11	Metering-Cover	91A-282	91A-282	91A-274
12	Metering-Cover Screw (4)	15C-53	15C-53	15C-19
+*13	Metering-Diaphragm	237-686	237-601	237-601
+*14	Metering-Diaphragm Gasket	16B-226	16B-226	16B-226
*15	Metering-By Pass Chamber Welch Plug (Large)	179-59	179-59	179-59
*16	Metering-Main Nozzle Welch Plug (Small)	179-60	179-60	179-60
*17	Metering-Main Nozzle Screen	95-180	95-180	95-180
18	Metering-Main Nozzle Screen Retaining Ring	55A-212	55A-212	55A-212
20	Idle Speed-Adjustment Screw			15C-21
B6	Idle Speed-Adjustment Screw Retainer			206-123
22	Low Speed-Mixture Needle	43-420	43-420	43A-70
23	Low Speed-Mixture Needle Spring	24B-331	24B-331	24B-331
24	High Speed-Mixture Needle	49B-1		43A-71
25	High Speed-Mixture Needle Spring			24B-449
26	High Speed-Governor Valve	15C-14	15C-14	
27	High Speed-Governor Valve Gasket	16B-184	16B-184	
B12	High Speed-Jet		49A-441	
A2	Choke-Shaft & Lever	26-1279		
A16	Choke-Shaft & Lever		26-1280	
A21	Choke-Shaft & Lever			26-1260
28	Choke-Friction Spring	24B-281	24B-281	
29	Choke-Friction Ball	206-121	206-121	
30	Choke-Shutter	27-342	27-342	27-331
31	Choke-Shutter Screw	15C-20	15C-20	15C-20
B2	Choke-Shaft Cover	91B-208	91B-208	
B3	Choke-Shaft Sleeve	102-204	102-204	
B8	Choke-Shaft O-Ring	44-296	44-296	
B10	Choke-Shaft Return Spring			24C-141
B17	Choke-Shaft E-Ring			29-220
C3	Choke-Lever			25-469
A9	Throttle-Shaft & Lever			13-2040
A16	Throttle-Shaft & Lever	13-2093	13-2037	
32	Throttle-Return Spring	24B-435	24B-360	24B-447
33	Throttle-Clip	29-224	29-224	
34	Throttle-Clip Retaining Screw	15C-20	15C-20	
35	Throttle-Shaft Washer			78A-226
36	Throttle-Shaft E-Ring			29-220
37	Throttle-Shutter	14A-26	14A-10	14-445
38	Throttle-Shutter Screw	15C-20	15C-20	15C-20
B3	Throttle-Shaft Sleeve	102-204		102-204
C4	Throttle-Lever			12B-363
B4	Throttle-Lever Retaining Screw			15B-348
*39	Flange Gasket	16B-228	16B-249	16B-228
	Repair Kit	RK-26HS	RK-23HS	RK-26HS
	Diaphragm & Gasket Set	DG-8HS	DG-5HS/T	DG-8HS

\*Indicates contents of Repair Kit

+Indicates contents of Diaphragm & Gasket Set



Carburetor Model		HS-251A	HS-252A	HS-254B
Customer		Jonsereds	Jonsereds	Husqvarna
Equipment Model No.		625	630	H66/H266/366
Venturi		11/16"-17.5 MM	11/16"-17.5 MM	11/16"-17.5 MM
Ref. No.	Part Name			
1	Fuel Pump-Cover	91-996	91A-273	91A-273
2	Fuel Pump-Cover Screw (4)	15C-30	15C-30	15C-30
+*3	Fuel Pump-Gasket	16B-227	16B-227	16B-227
+*4	Fuel Pump-Diaphragm	237-144	237-144	237-144
*5	Fuel Pump-Inlet Screen	95-177	95-177	95-177
*6	Fuel Inlet-Needle	34-216	34-216	34-216
*7	Fuel Inlet-Control Lever	155A-26	155A-26	155A-26
8	Fuel Inlet-Fulcrum Pin	32-78	32-78	32-78
9	Fuel Inlet-Fulcrum Pin Retaining Screw	15B-345	15B-345	15B-345
10	Fuel Inlet-Tension Spring	24B-323	24B-323	24B-299
11	Metering-Cover	91A-274	91A-274	91B-223
12	Metering-Cover Screw (4)	15C-19	15C-19	15C-19
+*13	Metering-Diaphragm	237-601	237-601	237-601
+*14	Metering-Diaphragm Gasket	16B-226	16B-226	16B-226
*15	Metering-By Pass Chamber Welch Plug (Large)	179-59	179-59	179-59
*16	Metering-Main Nozzle Welch Plug (Small)	179-60	179-60	
*17	Metering-Main Nozzle Screen	95-180	95-180	
18	Metering-Main Nozzle Screen Retaining Ring	55A-212	55A-212	
19	Metering-Nozzle Valve			363-619
20	Idle Speed-Adjustment Screw	15C-21		15C-21
21	Idle Speed-Adjustment Screw Spring			
B1	Idle Speed-Adjustment Screw Cup			
B6	Idle Speed-Adjustment Screw Retainer	206-123		206-123
22	Low Speed-Mixture Needle	43A-70	43A-70	43A-70
23	Low Speed-Mixture Needle Spring	24B-331	24B-331	24B-331
24	High Speed-Mixture Needle	43A-120	43A-71	43A-71
25	High Speed-Mixture Needle Spring	24B-449	24B-449	24B-449
26	High Speed-Governor Valve			
27	High Speed-Governor Valve Gasket			
A21	Choke-Shaft & Lever	26-1260	26-1260	
	Choke-Shaft & Lever			26-1266
28	Choke-Friction Spring			24B-281
29	Choke-Friction Ball			206-121
30	Choke-Shutter	27-331	27-331	27-331
31	Choke-Shutter Screw	15C-20	15C-20	15C-20
B10	Choke-Shaft Return Spring	24C-141	24C-141	
B17	Choke-Shaft E-Ring	29-220	29-220	
C3	Choke-Lever	25-469	25-469	
A9	Throttle-Shaft & Lever	13-2040	13-2012	
	Throttle-Shaft & Lever			13-2043
32	Throttle-Return Spring	24B-447	24B-434	24B-447
33	Throttle-Clip			
34	Throttle-Clip Retaining Screw			
35	Throttle-Shaft Washer	78A-226	78A-226	78A-226
36	Throttle-Shaft E-Ring	29-220	29-220	29-220
37	Throttle-Shutter	14-445	14-445	14-445
38	Throttle-Shutter Screw	15C-20	15C-20	15C-20
B3	Throttle-Shaft Sleeve	102-204	102-204	102-204
C2	Throttle-Lever	12B-363	12B-363	
B4	Throttle-Lever Retaining Screw	15B-348	15B-348	
*39	Flange Gasket	16B-228	16B-228	16B-228
	Repair Kit	RK-23HS	RK-23HS	RK-23HS
	Diaphragm & Gasket Set	DG-5HS/T	DG-5HS/T	DG-5HS/T

\*Indicates contents of Repair Kit

+Indicates contents of Diaphragm & Gasket Set

Carburetor Model		HS-255B	HS-256A
Customer		Husqvarna	Jonsereds
Equipment Model No.		H272KAP	J630
Venturi		11/16"-17.5 MM	11/16"-17.5 MM
Ref. No.	Part Name		
1	Fuel Pump-Cover	91A-273	91A-273
2	Fuel Pump-Cover Screw (4)	15C-30	15C-30
+*3	Fuel Pump-Gasket	16B-227	16B-227
+*4	Fuel Pump-Diaphragm	237-143	237-144
*5	Fuel Pump-Inlet Screen	95-177	95-177
*6	Fuel Inlet-Needle	34-216	34-216
*7	Fuel Inlet-Control Lever	155A-26	155A-26
8	Fuel Inlet-Fulcrum Pin	32-78	32-78
9	Fuel Inlet-Fulcrum Pin Retaining Screw	15B-345	15B-345
10	Fuel Inlet-Tension Spring	24B-345	24B-323
11	Metering-Cover	91A-274	91A-274
12	Metering-Cover Screw (4)	15C-19	15C-19
+*13	Metering-Diaphragm	237-601	237-601
+*14	Metering-Diaphragm Gasket	16B-226	16B-226
*15	Metering-By Pass Chamber Welch Plug (Large)	179-59	179-59
*16	Metering-Main Nozzle Welch Plug (Small)	179-60	179-60
*17	Metering-Main Nozzle Screen	95-180	95-180
18	Metering-Main Nozzle Screen Retaining Ring	55A-305	55A-212
19	Metering-Nozzle Valve	363-598	
20	Idle Speed-Adjustment Screw	15C-21	15C-21
21	Idle Speed-Adjustment Screw Spring		
B1	Idle Speed-Adjustment Screw Cup		
B6	Idle Speed-Adjustment Screw Retainer		
22	Low Speed-Mixture Needle	43A-70	43A-70
23	Low Speed-Mixture Needle Spring	24B-450	24B-331
24	High Speed-Mixture Needle	43A-71	43A-71
25	High Speed-Mixture Needle Spring	24B-449	24B-449
26	High Speed-Governor Valve	361-542	
27	High Speed-Governor Valve Gasket	16B-204	
A4	Choke-Shaft & Lever	26-1266	
A21	Choke-Shaft & Lever		26-1260
28	Choke-Friction Spring	24B-281	
29	Choke-Friction Ball	206-121	206-123
30	Choke-Shutter	27-331	
31	Choke-Shutter Screw	15C-20	15C-20
B10	Choke-Shaft Return Spring		24C-141
B17	Choke-Shaft E-Ring		29-220
C3	Choke-Lever		25-469
A5	Throttle-Shaft & Lever		13-2040
A9	Throttle-Shaft & Lever	13-2043	
32	Throttle-Return Spring	24B-447	24B-447
33	Throttle-Clip		
34	Throttle-Clip Retaining Screw		
35	Throttle-Shaft Washer	78A-280	78A-226
36	Throttle-Shaft E-Ring	29-220	29-220
37	Throttle-Shutter	14A-12	14-445
38	Throttle-Shutter Screw	15C-20	15C-20
B3	Throttle-Shaft Sleeve	102-204	102-204
C2	Throttle-Lever		12B-363
B4	Throttle-Lever Retaining Screw		15B-348
*39	Flange Gasket	16B-228	16B-228
	Repair Kit	RK-24HS	RK-23HS
	Diaphragm & Gasket Set	DG-2HS/T	DG-5HS/T

\*Indicates contents of Repair Kit

+Indicates contents of Diaphragm & Gasket Set

Carburetor Model		HS-260A	HS-265A	HS-273A
Customer		Husqvarna	Jonsereds	Dolmar
Equipment Model No.		H268XPS	J2084	PC7314
Venturi		11/16"-17.5 MM	11/16"-17.5 MM	
Ref. No.	Part Name			
1	Fuel Pump-Cover	91A-273	91-761	91-1010
2	Fuel Pump-Cover Screw (4)	15C-30	15C-30	15C-30
+*3	Fuel Pump-Gasket	16B-227	16B-227	16B-227
+*4	Fuel Pump-Diaphragm	237-144	237-144	237-144
*5	Fuel Pump-Inlet Screen	95-177	95-177	95-233
*6	Fuel Inlet-Needle	34-216	34-216	34-219
*7	Fuel Inlet-Control Lever	155A-26	155A-26	155A-26
8	Fuel Inlet-Fulcrum Pin	32-78	32-78	32-78
9	Fuel Inlet-Fulcrum Pin Retaining Screw	15B-345	15B-345	15B-345
10	Fuel Inlet-Tension Spring	24B-299	24B-323	24B-345
B5	Fuel Inlet-Seat			
11	Metering-Cover	91B-233	91A-274	91B-255
12	Metering-Cover Screw (4)	15C-19	15C-19	15C-19
+*13	Metering-Diaphragm	237-601	237-601	237-601
+*14	Metering-Diaphragm Gasket	16B-226	16B-226	16B-226
*15	Metering-By Pass Chamber Welch Plug (Large)	179-59	179-59	179-59
*16	Metering-Main Nozzle Welch Plug (Small)			
*17	Metering-Main Nozzle Screen			
18	Metering-Main Nozzle Screen Retaining Ring		55A-305	
19	Metering-Nozzle Valve	363-616	363-619	363-639
20	Idle Speed-Adjustment Screw	15C-21	15C-21	15C-44
21	Idle Speed-Adjustment Screw Spring			
B1	Idle Speed-Adjustment Screw Cup			
B6	Idle Speed-Adjustment Screw Retainer	206-123		55A-305
22	Low Speed-Mixture Needle	43A-70	43A-70	43A-172
23	Low Speed-Mixture Needle Spring	24B-331	24B-331	24B-331
24	High Speed-Mixture Needle	43A-152	43A-71	43A-173
25	High Speed-Mixture Needle Spring	24B-449	24B-449	24B-331
26	High Speed-Governor Valve			
27	High Speed-Governor Valve Gasket			
A4	Choke-Shaft & Lever	26-1266	26-1274	
A21	Choke-Shaft & Lever			26-1304
28	Choke-Friction Spring	24B-281		24B-281
29	Choke-Friction Ball	206-121		206-121
30	Choke-Shutter	27-331	27-331	27-331
31	Choke-Shutter Screw	15C-20	15C-20	15C-20
B10	Choke-Shaft Return Spring		24C-141	
B17	Choke-Shaft E-Ring			
C3	Choke-Lever		25-469	
C5	Choke-Lever		25-457	
A3	Throttle-Shaft & Lever			13-2043
A5	Throttle-Shaft & Lever		13-2049	
A9	Throttle-Shaft & Lever	13-2043		24B-447
B4	Throttle-Lever Retaining Screw		15B-348	
32	Throttle-Return Spring	24B-447	24C-239	
33	Throttle-Clip			
34	Throttle-Clip Retaining Screw			
35	Throttle-Shaft Washer	78A-226	78A-280	78A-226
36	Throttle-Shaft E-Ring	29-220	29-220	29-220
37	Throttle-Shutter	14-445	14A-8	14-445
38	Throttle-Shutter Screw	15C-20	15C-20	15C-20
B3	Throttle-Shaft Sleeve	102-204		102-204
C2	Throttle-Lever		12B-363	
B4	Throttle-Lever Retaining Screw		15B-348	
*39	Flange Gasket	16B-228		
46				49B-43
	Repair Kit	RK-23HS	RK-23HS	RK-32HS
	Diaphragm & Gasket Set	DG-5HS/T	DG-5HS/T	DG-5HS/T

\*Indicates contents of Repair Kit

+Indicates contents of Diaphragm & Gasket Set

Carburetor Model		HS-274E	HS-275B	HS-276D
Customer		Stihl	Stihl	Stihl
Equipment Model No.				
		4223-120-0600D	4221	4221-120-0602C
Venturi				
Ref. No.	Part Name			
1	Fuel Pump-Cover	91-786	91A-273	91A-273
2	Fuel Pump-Cover Screw (4)	15C-30	15C-30	15C-30
+*3	Fuel Pump-Gasket	16B-227	16B-227	16B-227
+*4	Fuel Pump-Diaphragm	237-143	237-143	237-143
*5	Fuel Pump-Inlet Screen	95-233	95-233	95-233
*6	Fuel Inlet-Needle	34-219	34-219	34-219
*7	Fuel Inlet-Control Lever	155A-71	155A-71	155A-71
8	Fuel Inlet-Fulcrum Pin	32-78	32-78	32-78
9	Fuel Inlet-Fulcrum Pin Retaining Screw	15B-345	15B-345	15B-345
10	Fuel Inlet-Tension Spring	24B-345	24B-345	24B-345
11	Metering-Cover	91-1006	91-1003	91-1003
12	Metering-Cover Screw (4)	15C-19	15C-53	15C-53
+*13	Metering-Diaphragm	237-653	237-653	237-653
+*14	Metering-Diaphragm Gasket	16B-226	16B-226	16B-226
*15	Metering-By Pass Chamber Welch Plug (Large)	179-59	179-59	179-59
*16	Metering-Main Nozzle Welch Plug (Small)			
*17	Metering-Main Nozzle Screen			
18	Metering-Main Nozzle Screen Retaining Ring			
19	Metering-Nozzle Valve	363-643	363-626	363-626
20	Idle Speed-Adjustment Screw	15C-44	15C-44	15C-44
21	Idle Speed-Adjustment Screw Spring			
B1	Idle Speed-Adjustment Screw Cup			
B6	Idle Speed-Adjustment Screw Retainer	55A-305	55A-305	55A-305
22	Low Speed-Mixture Needle	43A-176	43A-176	43A-176
23	Low Speed-Mixture Needle Spring	24B-331	24B-331	24B-331
24	High Speed-Mixture Needle	43A-173		43A-177
25	High Speed-Mixture Needle Spring	24B-331		24B-331
26	High Speed-Governor Valve			
27	High Speed-Governor Valve Gasket			
B8	High Speed-Mixture Screw 'O' Ring	44-350	44-350	44-350
A4	Choke-Shaft & Lever	26A-215		
A21	Choke-Shaft & Lever		26-1306	26-1306
A22	Choke-Shaft & Lever			
A23	Choke-Shaft & Lever		26A-212	26A-212
30	Choke-Shutter	27-372	27-331	27-331
31	Choke-Shutter Screw	15C-20	15C-20	15C-20
B10	Choke-Shaft Return Spring	24C-266	24C-272	24C-264
B17	Choke-Shaft E-Ring	29-220	29-220	29-220
B9	Choke-Shaft Dust Seal (2)	44-347	44-347	44-347
B3	Choke-Dust Seal Retainer (2)	102-219	102-217	102-219
B14	Choke-Plastic Lever		25-494	25-494
B15	Choke-Compression Spring	24C-266		
A3	Throttle-Shaft & Lever	13-2112	13-2111	13-2091
32	Throttle-Return Spring	24C-265	24C-29	24C-29
35	Throttle-Shaft Washer	78A-226	78A-226	78A-226
36	Throttle-Shaft E-Ring	29-220	29-220	29-220
37	Throttle-Shutter	14A-58	14A-42	14A-42
38	Throttle-Shutter Screw	15C-20	15C-20	15C-20
B5	Throttle-Wire Connector		28-176	28-176
C2	Throttle-Lever	12B-448		
B4	Throttle-Lever Retaining Screw	15B-348	15B-348	15B-348
B7	Throttle-Shaft Sleeve		102-204	102-204
B18	Throttle-Wire Connector E-Ring		29-223	29-223
C5	Throttle-Shaft Lever	12B-448		
	Jet-Remote Fixed	49B-4	49B-14	49A-499
	Jet-Part Throttle	363-625	363-625	363-625
	Repair Kit	RK-28HS	RK-28HS	RK-28HS
	Diaphragm & Gasket Set	DG-7HS	DG-7HS	DG-7HS

\*Indicates contents of Repair Kit

+Indicates contents of Diaphragm & Gasket Set

Carburetor Model		HS-277A	HS-278F
Customer		Stihl	Wacker
Equipment Model No.			
		4205	BS 700
Venturi			
Ref. No.	Part Name		
1	Fuel Pump-Cover	91-761	91A-273
2	Fuel Pump-Cover Screw (4)	15C-30	15C-30
+*3	Fuel Pump-Gasket	16B-227	16B-227
+*4	Fuel Pump-Diaphragm	237-144	237-144
*5	Fuel Pump-Inlet Screen	95-233	95-188
*6	Fuel Inlet-Needle	34-216	34-216
*7	Fuel Inlet-Control Lever	155A-71	155A-26
8	Fuel Inlet-Fulcrum Pin	32-78	32-78
9	Fuel Inlet-Fulcrum Pin Retaining Screw	15B-345	15B-345
10	Fuel Inlet-Tension Spring	24B-299	24B-299
11	Metering-Cover	91-1009	91B-253
12	Metering-Cover Screw (4)	15C-19	15C-53
+*13	Metering-Diaphragm	237-653	237-686
+*14	Metering-Diaphragm Gasket	16B-226	16B-226
*15	Metering-By Pass Chamber Welch Plug (Large)	179-59	179-59
*16	Metering-Main Nozzle Welch Plug (Small)		
*17	Metering-Main Nozzle Screen		
18	Metering-Main Nozzle Screen Retaining Ring		
19	Metering-Nozzle Valve	363-518	363-656
20	Idle Speed-Adjustment Screw	15C-44	15B-330
21	Idle Speed-Adjustment Screw Spring		24B-298
B1	Idle Speed-Adjustment Screw Cup		
B6	Idle Speed-Adjustment Screw Retainer	55A-305	
22	Low Speed-Mixture Needle	43A-179	49B-5
23	Low Speed-Mixture Needle Spring	24B-331	
24	High Speed-Mixture Needle	43A-178	
25	High Speed-Mixture Needle Spring	24B-331	
26	High Speed-Governor Valve	361-545	
27	High Speed-Governor Valve Gasket	16B-204	
A4	Choke-Shaft & Lever		
A21	Choke-Shaft & Lever	26-1301	26-1308
28	Choke-Friction Spring		24B-281
29	Choke-Friction Ball		206-121
30	Choke-Shutter	27-331	27-374
31	Choke-Shutter Screw	15C-20	15C-20
B10	Choke-Shaft Return Spring	24C-267	
B17	Choke-Shaft E-Ring		
C3	Choke-Lever		
A5	Throttle-Shaft & Lever	13-2091	13-2109
A9	Throttle-Shaft & Lever		
32	Throttle-Return Spring	24C-29	24B-435
33	Throttle-Clip		
34	Throttle-Clip Retaining Screw		
35	Throttle-Shaft Washer		
36	Throttle-Shaft E-Ring	29-220	
37	Throttle-Shutter	14-445	14-471
38	Throttle-Shutter Screw	15C-20	15C-20
B3	Throttle-Shaft Sleeve	102-217	102-204
C2	Throttle-Lever		12B-436
B4	Throttle-Lever Retaining Screw		15B-348
		102-204	
49	Main Jet Seal Screw (2)		15C-14
50	Sealing Gasket		16B-184
	Repair Kit	RK-21HS	RK-26HS
	Diaphragm & Gasket Set	DG-3HS	DG-8HS

\*Indicates contents of Repair Kit

+Indicates contents of Diaphragm & Gasket Set

Carburetor Model		HS-279D	HS-280A	HS-281A
Customer		Stihl	Stihl	Stihl
Equipment Model No.				
		4223	4205	4205
Venturi				
Ref. No.	Part Name			
1	Fuel Pump-Cover	91-786	91-761	91-761
2	Fuel Pump-Cover Screw (4)	15C-30	15C-30	15C-30
+*3	Fuel Pump-Gasket	16B-227	16B-227	16B-227
+*4	Fuel Pump-Diaphragm	237-143	237-144	237-144
*5	Fuel Pump-Inlet Screen	95-233	95-233	95-233
*6	Fuel Inlet-Needle	34-219	34-219	34-219
*7	Fuel Inlet-Control Lever	155A-71	155A-71	155A-71
8	Fuel Inlet-Fulcrum Pin	32-78	32-78	32-78
9	Fuel Inlet-Fulcrum Pin Retaining Screw	15B-345	15B-345	15B-345
10	Fuel Inlet-Tension Spring	24B-345	24B-299	24B-299
11	Metering-Cover	91-1006	91-1009	91-1009
12	Metering-Cover Screw (4)	15C-19	15C-19	15C-19
+*13	Metering-Diaphragm	237-653	237-653	237-653
+*14	Metering-Diaphragm Gasket	16B-226	16B-226	16B-226
*15	Metering-By Pass Chamber Welch Plug (Large)	179-59	179-59	179-59
*16	Metering-Main Nozzle Welch Plug (Small)			
*17	Metering-Main Nozzle Screen			
18	Metering-Main Nozzle Screen Retaining Ring			
19	Metering-Nozzle Valve	363-643	363-626	363-626
20	Idle Speed-Adjustment Screw	15C-44	15C-44	15C-44
21	Idle Speed-Adjustment Screw Spring			
B1	Idle Speed-Adjustment Screw Cup			
B6	Idle Speed-Adjustment Screw Retainer	55A-305	55A-305	55A-305
22	Low Speed-Mixture Needle	43A-176	43A-187	43A-187
23	Low Speed-Mixture Needle Spring	24B-331	24C-270	24C-270
24	High Speed-Mixture Needle		43A-188	43A-188
25	High Speed-Mixture Needle Spring		24C-270	24C-270
26	High Speed-Governor Valve			
27	High Speed-Governor Valve Gasket		16B-204	16B-204
A4	Choke-Shaft & Lever			
A21	Choke-Shaft & Lever	26A-215	26-1301	26-1301
28	Choke-Friction Spring			
29	Choke-Friction Ball			
30	Choke-Shutter	27-372	27-331	27-331
31	Choke-Shutter Screw	15C-20	15C-20	15C-20
B10	Choke-Shaft Return Spring		24C-267	24C-267
A5	Throttle-Shaft & Lever	13-2112	13-2111	13-2111
A9	Throttle-Shaft & Lever			
32	Throttle-Return Spring	24C-265	24C-29	24C-29
33	Throttle-Clip			
34	Throttle-Clip Retaining Screw			
35	Throttle-Shaft Washer	78A-226	78A-226	78A-226
36	Throttle-Shaft E-Ring	29-220	29-220	29-220
37	Throttle-Shutter	14A-58	14-445	14-445
38	Throttle-Shutter Screw	15C-20	15C-20	15C-20
B3	Throttle-Shaft Sleeve	102-219	102-217	102-217
C2	Throttle-Lever	12B-448		
B4	Throttle-Lever Retaining Screw	15B-348		
*39	Flange Gasket			
40	O-Ring		44-350	44-350
	Adjustment Limiter Module		198-584	198-584
45	Adjustment Cap		318-32	318-32
46	Remote Main Jet		49B-4	49B-4
47	Part Throttle Jet	363-625	363-625	363-625
	Repair Kit	RK-28HS	RK-29HS	RK-29HS
	Diaphragm & Gasket Set	DG-7HS	DG-3HS/T	DG-3HS/T

\*Indicates contents of Repair Kit

+Indicates contents of Diaphragm & Gasket Set



Carburetor Model		HS-284E	HS-285A	HS-286A
Customer		Wacker	Wacker	Dolmar
Equipment Model No.				
		500/600	700L	PS6000
Venturi		13.0MM	14.3MM	5/8
Ref. No.	Part Name			
1	Fuel Pump-Cover	91A-273	91A-273	91-1005
2	Fuel Pump-Cover Screw (4)	15C-30	15C-30	15C-30
+*3	Fuel Pump-Gasket	16B-227	16B-227	16B-227
+*4	Fuel Pump-Diaphragm	237-144	237-144	237-144
*5	Fuel Pump-Inlet Screen	95-188	95-188	95-177
*6	Fuel Inlet-Needle	34-216	34-216	34-219
*7	Fuel Inlet-Control Lever	155A-26	155A-26	155A-26
8	Fuel Inlet-Fulcrum Pin	32-78	32-78	32-78
9	Fuel Inlet-Fulcrum Pin Retaining Screw	15B-345	15B-345	15B-345
10	Fuel Inlet-Tension Spring	24B-299	24B-299	24B-435
11	Metering-Cover	91B-253	91B-253	91B-253
12	Metering-Cover Screw (4)	15C-53	15C-53	15C-19
+*13	Metering-Diaphragm	237-686	237-686	237-601
+*14	Metering-Diaphragm Gasket	16B-226	16B-226	16B-226
*15	Metering-By Pass Chamber Welch Plug (Large)	179-59	179-59	179-59
*16	Metering-Main Nozzle Welch Plug (Small)			
*17	Metering-Main Nozzle Screen			
18	Metering-Main Nozzle Screen Retaining Ring			
19	Metering-Nozzle Valve	363-656	363-598	363-626
20	Idle Speed-Adjustment Screw	15B-330	15B-330	15C-21
21	Idle Speed-Adjustment Screw Spring	24B-298	24B-298	
B1	Idle Speed-Adjustment Screw Cup			
B6	Idle Speed Adjustment Screw Spring			206-123
22	Low Speed-Mixture Needle	49B-5	49B-5	43A-187
23	Low Speed-Mixture Needle Spring			24C-270
24	High Speed-Mixture Needle		49B-80	43A-206
25	High Speed-Mixture Needle Spring			24C-270
26	High Speed-Governor Valve			
27	High Speed-Governor Valve Gasket	16B-184		
A4	Choke-Shaft & Lever			
A2	Choke-Shaft & Lever	26-1308	26-1308	
28	Choke-Friction Spring	24B-281	24B-281	
29	Choke-Friction Ball	206-121	206-121	
30	Choke-Shutter	27-374	27-374	
31	Choke-Shutter Screw	15C-20	15C-20	
°B18	Choke - Valve Inlet Needle			34-224
°B14	Choke - Valve Sleeve			62A-114
°B15	Choke - Valve Tension Spring			24C-228
	Choke - Valve Retaining Screw			15B-446
	Choke -			
A16	Throttle-Shaft & Lever	13-2109	13-2109	
A20	Throttle-Shaft & Lever			13-1956
32	Throttle-Return Spring	24B-435	24B-435	24C-29
37	Throttle-Shutter	14-471	14-471	14-431
38	Throttle-Shutter Screw	15C-20	15C-20	15C-20
B3	Throttle-Shaft Sleeve	102-204	102-204	
C2	Throttle-Lever	12B-436	12B-436	
B4	Throttle-Lever Retaining Screw	15B-348	15B-348	
	Low/High Speed - Mixture Needle O-Ring			44-350
	Adjustment Limiter Module			198-402
	Adjustment Limiter Cap (2)			318-32
	Remote Fixed Jet			49B-4
		15C-14	15C-14	
	Choke-Valve			392-506
	Repair Kit	RK-26HS	RK-26HS	RK-23HS
	Diaphragm & Gasket Set	DG-8HS	DG-8HS	DG-5HS/T

\*Indicates contents of Repair Kit

+Indicates contents of Diaphragm & Gasket Set



Carburetor Model		HS-294A	HS-295A	HS-296A
Customer		Dolmar	Dolmar	Husqvarna
Equipment Model No.		PS-9010	PS-9010	Husky H385
Venturi		23/32" 18.3MM	23/32" 18.3MM	11/16" 17.46MM
Ref. No.	Part Name			
1	Fuel Pump-Cover	91-988	91-988	91-1008
2	Fuel Pump-Cover Screw (4)	15C30	15C30	15C30
+*3	Fuel Pump-Gasket	16B-227	16B-227	16B-227
+*4	Fuel Pump-Diaphragm	237-144	237-144	237-144
*5	Fuel Pump-Inlet Screen	95-177	95-177	95-233
*6	Fuel Inlet-Needle	34-219	34-219	34-219
*7	Fuel Inlet-Control Lever	155A26	155A26	155A-26
8	Fuel Inlet-Fulcrum Pin	32-78	32-78	32-78
9	Fuel Inlet-Fulcrum Pin Retaining Screw	15B345	15B345	15B345
10	Fuel Inlet-Tension Spring	24B-323	24B-323	24B-299
B5	Fuel Inlet-Seat			
11	Metering-Cover	91A-352	91A-352	91B-223
12	Metering-Cover Screw (4)	15C-19	15C-19	15C-19
+*13	Metering-Diaphragm	237-601	237-601	237-601
+*14	Metering-Diaphragm Gasket	16B-226	16B-226	16B-226
*15	Metering-By Pass Chamber Welch Plug (Large)	179-59	179-59	179-62
*16	Metering-Main Nozzle Welch Plug (Small)			
*17	Metering-Main Nozzle Screen			
18	Metering-Main Nozzle Screen Retaining Ring			
19	Metering-Nozzle Valve	363-598	363-598	363-598
20	Idle Speed-Adjustment Screw	15C-44	15C-58	15C-21
21	Idle Speed-Adjustment Screw Spring			
B1	Idle Speed-Adjustment Screw Cup	55A-305	55A-305	55A-305
B6	Idle Speed Adjustment Screw Spring			
22	Low Speed-Mixture Needle	43A-176	43A-187	43A-211
23	Low Speed-Mixture Needle Spring	24B-331	24C-270	24C-280
24	High Speed-Mixture Needle	43A-177	43A-188	43A-210
25	High Speed-Mixture Needle Spring	24B-331	24C-270	24C-280
A3	Choke-Shaft & Lever			13-2127
A4	Choke-Shaft & Lever	26-1311	26-1311	
A8	Choke-Shaft & Lever	13-2076	13-2076	
A23	Choke-Shaft & Lever			26-1310
28	Choke-Friction Spring	24B-281	24B-281	24B-281
29	Choke-Friction Ball	206-121	206-121	206-121
30	Choke-Shutter	27-331	27-331	27-331
31	Choke-Shutter Screw	15C-20	15C-20	15C-20
B2	Choke-Shaft Cover			
B3	Choke-Shaft Sleeve	102-204	102-204	102-217
B8	Choke-Shaft O-Ring	44-350	44-350	44-350
B10	Choke-Shaft Return Spring			24C-279
B17	Choke-Shaft E-Ring	29-223	29-223	
C3	Choke-Lever			25-498
C5	Choke-Lever			25-457
B3	Throttle-Shaft Sleeve			102-208
B4	Throttle-Lever Retaining Screw			15B-348
32	Throttle-Return Spring	24C-29	24C-29	24C-281
33	Throttle-Clip			
34	Throttle-Clip Retaining Screw			
35	Throttle-Shaft Washer	78A-226	78A-226	78A-226
36	Throttle-Shaft E-Ring	29-220	29-220	29-220
37	Throttle-Shutter	14A-23	14A-23	14A-67
38	Throttle-Shutter Screw	15C-20	15C-20	15C-20
*39	Flange Gasket			
40	O-Ring	44-350	44-350	
	Repair Kit	RK-34HS	RK-34HS	RK-32HS
	Diaphragm & Gasket Set	DG-5HS/T	DG-5HS/T	DG-5HS/T

\*Indicates contents of Repair Kit

+Indicates contents of Diaphragm & Gasket Set

Carburetor Model		HS-297A	HS-298A
Customer		Husqvarna	Husqvarna
Equipment Model No.		Husky J 2095	Husky H395
Venturi		11/16" 17.46MM	11/16" 17.46MM
Ref. No.	Part Name		
1	Fuel Pump-Cover	91-761	91-1008
2	Fuel Pump-Cover Screw (4)	15C-30	15C-30
+*3	Fuel Pump-Gasket	16B-227	16B-227
+*4	Fuel Pump-Diaphragm	237-144	237-144
*5	Fuel Pump-Inlet Screen	95-233	95-233
*6	Fuel Inlet-Needle	34-219	34-219
*7	Fuel Inlet-Control Lever	155A-26	155A-26
8	Fuel Inlet-Fulcrum Pin	32-78	32-78
9	Fuel Inlet-Fulcrum Pin Retaining Screw	15B-345	15B-345
10	Fuel Inlet-Tension Spring	24B-299	24B-299
B5	Fuel Inlet-Seat		
11	Metering-Cover	91A-274	91B-223
12	Metering-Cover Screw (4)	15C-19	15C-19
+*13	Metering-Diaphragm	237-601	237-601
+*14	Metering-Diaphragm Gasket	16B-226	16B-226
*15	Metering-By Pass Chamber Welch Plug (Large)	179-62	179-62
*16	Metering-Main Nozzle Welch Plug (Small)		
*17	Metering-Main Nozzle Screen		
18	Metering-Main Nozzle Screen Retaining Ring		
19	Metering-Nozzle Valve	363-598	363-598
20	Idle Speed-Adjustment Screw	15C-21	15C-55
21	Idle Speed-Adjustment Screw Spring	55A-305	
B1	Idle Speed-Adjustment Screw Cup		55A-305
B6	Idle Speed Adjustment Screw Spring		
22	Low Speed-Mixture Needle	43A-211	43A-211
23	Low Speed-Mixture Needle Spring	24C-280	24C-280
24	High Speed-Mixture Needle	43A-210	43A-210
25	High Speed-Mixture Needle Spring	24C-280	24C-280
26	High Speed-Governor Valve		
27	High Speed-Governor Valve Gasket		
B7	High Speed-Sealing Screw Gasket	78A-352	
A1	Choke-Shaft & Lever		
A2	Choke-Shaft & Lever		
A3	Choke-Shaft & Lever	13-2049	13-2127
A23	Choke-Shaft & Lever	26-1274	26-1310
28	Choke-Friction Spring		24B-281
29	Choke-Friction Ball		206-121
30	Choke-Shutter	27-331	27-331
31	Choke-Shutter Screw	15C-20	15C-20
B2	Choke-Shaft Cover		
B3	Choke-Shaft Sleeve		102-217
B4		15B-348	15B-348
B8	Choke-Shaft O-Ring	44-350	44-350
B10	Choke-Shaft Return Spring	24C-141	24C-279
C2	Choke-Lever		
C3	Choke-Lever	25-469	25-498
C4			
C5	Choke-Lever	25-457	25-457
B3	Throttle-Shaft Sleeve		102-208
32	Throttle-Return Spring	24C-239	24C-281
33	Throttle-Clip		
34	Throttle-Clip Retaining Screw		
35	Throttle-Shaft Washer	78A-280	78A-226
36	Throttle-Shaft E-Ring	29-220	29-220
37	Throttle-Shutter	14A-67	14A-67
38	Throttle-Shutter Screw	15C-20	15C-20
	Repair Kit	RK-32HS	RK-32HS
	Diaphragm & Gasket Set	DG-5HS/T	DG-5HS/T

\*Indicates contents of Repair Kit

+Indicates contents of Diaphragm & Gasket Set